

CHEMISTRY PP1 QUESTIONS 1996-2016

WhatsApp/Sms/Call *Sir Obiero Amos* @

0706 851 439 for Marking Schemes

2006-2016



By Sir Obiero Amos Resources

WhatsApp /Sms/Call
0706851439

MAKE WORK EASIER WITH AMOBI SOFT
COPY PUBLISHERS. SOLUTIONS TO ALL
YOUR SOFTCOPY RESOURCES

FOR A VARIETY OF REVISION KITS

WhatsApp/Sms/Call

By Sir Obiero Resources 0706851439

CHEMISTRY PAPER 233/1

K.C.S.E 1995 QUESTIONS

1. The electron arrangement ions X^{3-} and Y^{2-} are 2, 8, and 2, 8, 8 respectively.
- (a) Write the electronic arrangement of the elements X and Y. (2 mks)
- (b) Write the formula of the compound that would be formed between X and Y.

2. When bromine gas reacts with aqueous sodium hydroxide, the *equilibrium* represented by the equation: $Br_{2(aq)} + 2OH^{-}_{(aq)} \rightleftharpoons Br^{-}_{(aq)} + OBR^{-}_{(aq)} + H_2O$ is established.

What observations would be made if a few drops of sulphuric acid were added to the equilibrium mixture? Explain.

3. Calculate the amount of calcium carbonate that would remain if 15.0g of calcium carbonate were reacted with 0.2 moles of hydrochloric acid.

The equation for the reaction is $CaCO_{3(g)} + 2HCl \rightarrow CaCl_{2(aq)} + CO_{2(g)} + H_2O(g)$
(C = 12.0, O = 16.0, Ca = 40.0)

4. In an experiment, soap solution was added to three separate samples of water. The table below shows the volumes of soap solution required to form lather with 1000cm³ of each sample of water before and after boiling.

	Sample I	Sample II	Sample III
Volume of soap before water is boiled (cm ³)	27.0	3.0	10.6
Volume of soap after water is boiled	27.0	3.0	3.0

- a) Which water sample is likely to be soft? Explain. (2mks)
- b) Name the change in the volume of soap solution used in sample III (1mk)
5. a) Name one natural fibre.
- b) Give one advantage of synthetic fibres over natural fibres. (1mk)

6. The table below gives some properties of gases D and E.

Gas	Density	Effects of $H_2SO_{4(aq)}$	Effects of $NaOH_{(aq)}$
D	Lighter than air	Reacts to form a salt	Dissolves without reacting

E	Heavier than air	Not affected	Not affected.
---	------------------	--------------	---------------

- a) Describe how you would obtain a sample of E from a mixture of gases D and E. (2mks)
- b) Suggest a possible identity of gas D. Give a reason for your answer. (1mk)

7. The curve below represents the variation of temperature with time when pure and impure samples of a solid were heated separately.

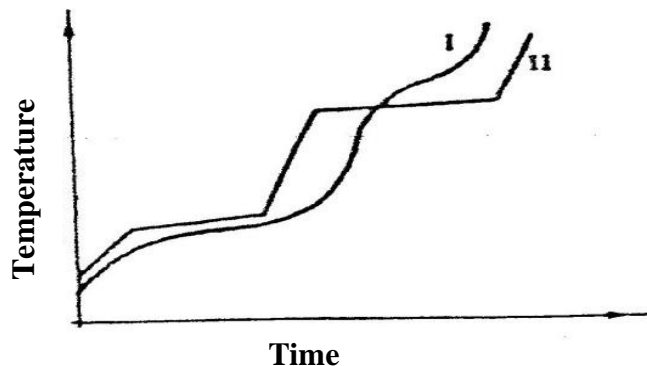

Which curve shows the variation in temperature for the pure solid? Explain (2mks)

8. The diagram below represents a set – up that can be used to prepare and collect oxygen.

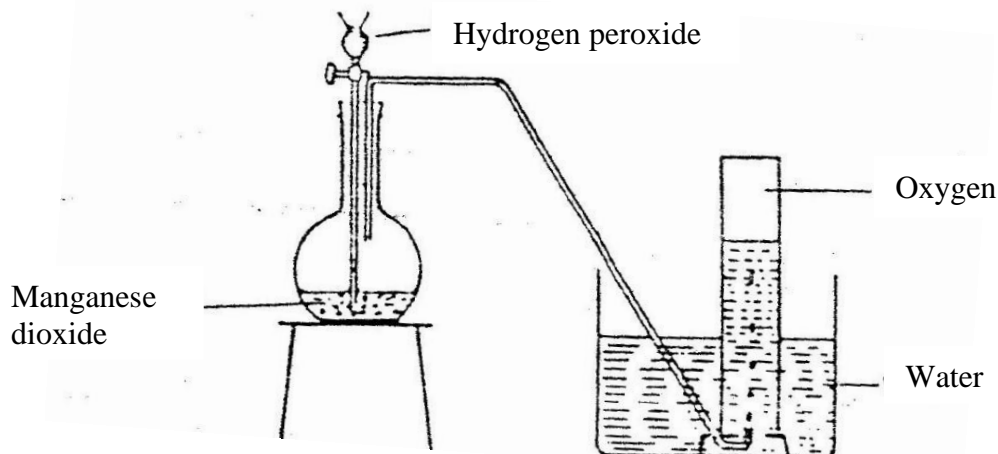

- a) Write an equation for the reaction that takes place (1mk)
- b) What property of oxygen makes it possible for its collection as indicated by the diagram (1mk)
- c) Explain why it is important not to collect any gas for the first few. Seconds

of the experiment.

(1mk)

9. Study the set – up below and answer the question that follows.

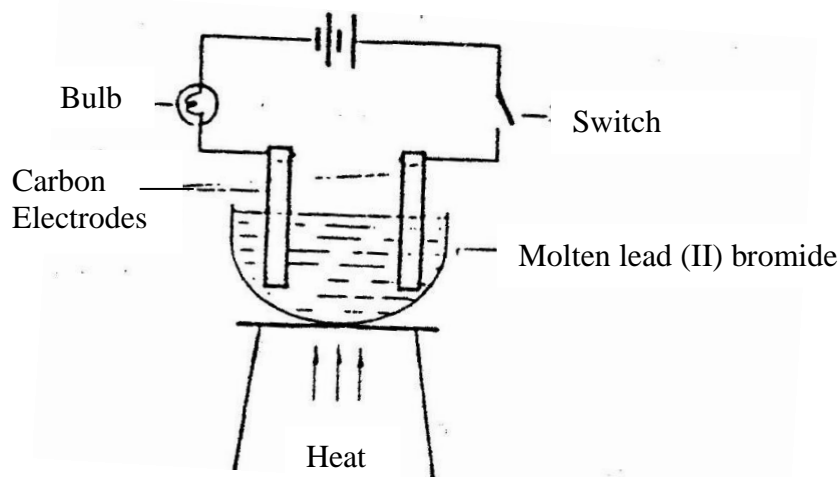

State and explain the observations that would be made when the circuit is completed.

10. In an experiment, rods of metals P, Q and R were cleaned with sand paper and placed in a beaker containing water. Another set of rods was also cleaned and placed in a beaker containing dilute acid. After placing the rods in the two liquids bubbles of gas were seen around some of the rods as shown in the diagrams below.

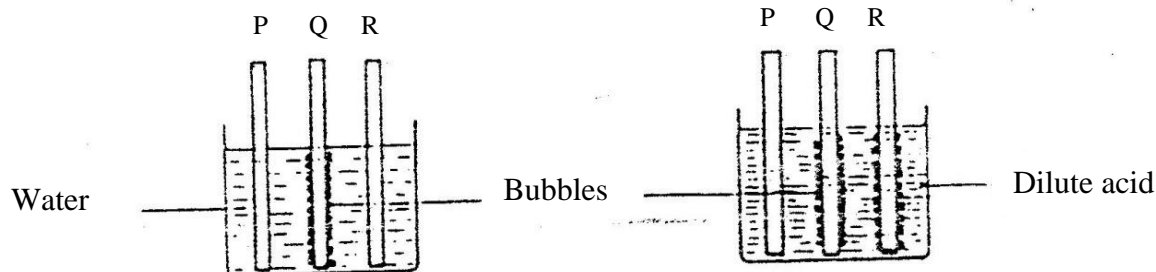

- a) Why is it necessary to clean the rods with sand paper before dipping them into the liquids. (1mk)
- b) Arrange the three metals in order of their reactivity starting with the most reactive.
11. A Solution of chlorine in tetra chloromethane turns colourless when propene gas is bubble though it.
- a) What type of reaction takes place? (1mk)
- b) Write an equation for the above reaction (1mk)

12. With reference to atomic number of one, explain why hydrogen can be placed in either group I and VII of the periodic table. (2mks)
13. a) Explain why it is not advisable to use wood ash for cleaning aluminium Utensils (2mks)
 b) Duralumin is an alloy of aluminium. What is the advantage of using duralumin in place of aluminium for manufacture of aeroplane parts. (1mk)
14. A compound has an empirical formula, C_3H_6O and a relative formula mass of 16. Determine its molecular formula (H = 1.0, C = 12.0, O = 16.0) (2mk)
15. Explain how you would separate mixture of nitrogen and oxygen gases given that their boiling points are -196°C and -183°C respectively (2mks)
16. Study the table below and answer the questions that follow.

Alkane	Formula	Heat of combustion (ΔH_c) kJmol^{-1}
Methane	CH_4	890
Ethane	C_2H_6	1560
Propane	C_3H_8	2220
Butane	C_4H_{10}	

- a) Predict the heat of combustion of butane and write it on the space provided in the table above? (1mk)
- b) What does the sign of ΔH_c value indicate about combustion of alkenes? (1mk)
17. The diagram below represents the extraction of sulphur by Frasch process

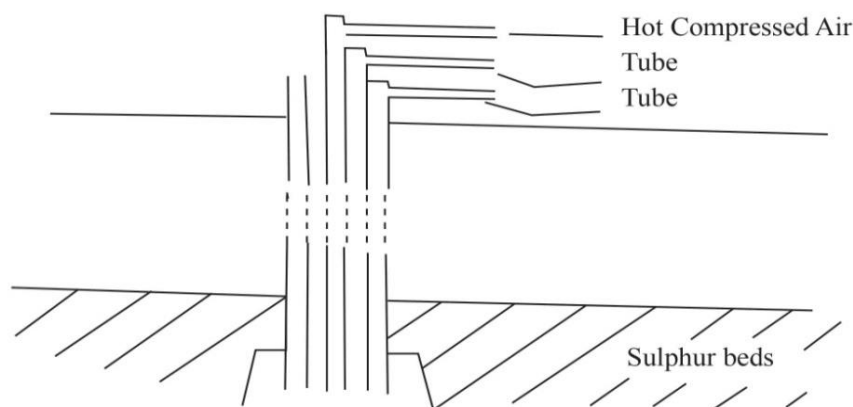

a) Name the substance that passes through tube;

I

II

b) What is the purpose of hot compressed air in this process?

(1mk)

18. Study the diagram below and answer the questions that follow.

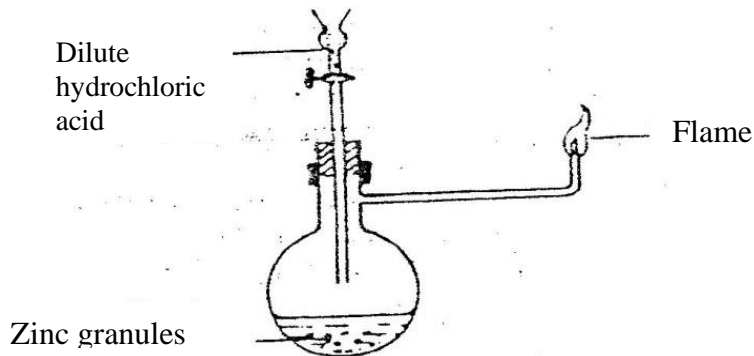

Write an equation for each of the two reactions that take place in the experiment represented by the diagram above

(2mks)

19. A mixture containing equal volumes of hydrogen and carbon dioxide was introduced one end of a tube as shown below.

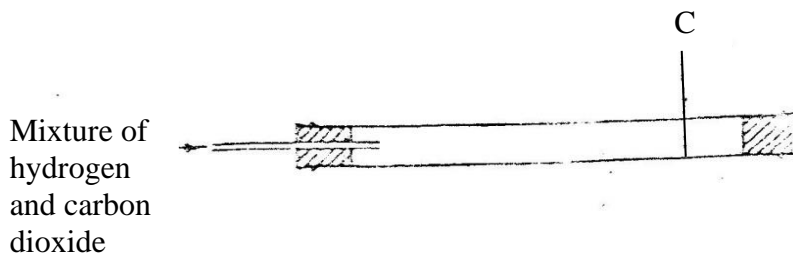

Which gas would be detected at point C in first? Explain

(2mks)

20. The table below gives three experiments on the reaction of excess sulphuric acid and 0.5g of zinc done under different conditions. In each the volume of gas was recorded at different time intervals.

Experiment	Form of Zinc	Sulphuric acid solution
I	Power	0.8m
II	Power	1.0m
III	Granules	0.8m

On the axis below draw and label the three curves that could be obtained from such results.

21. The table shows how solubility of some substances in water varies with temperature.

Substance	Change of O°C	Solubility 20° C	With temperature 40°C	(g/100cm ³ of water) 60°C
W	0.334	0.16	0.097	0.0058
X	27.60	34.0	40.0	45.5
Y	35.70	36.0	36.6	37.3

Which of the above substances is likely to be a gas? Explain (2mks)

22. Dilute nitric acid reacts with copper according to the equation;

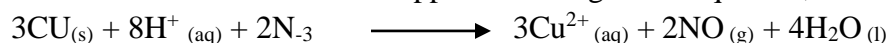

a) What is the oxidation number of nitrogen in?

i) 2N^{-3}

ii) NO

b) With respect to nitrogen, explain whether the above reaction is an oxidation or reduction process. (1mk)

23. Explain the following observation. A chloride dissolves in water to form an electrolyte while the same chloride dissolves in methylbenzene to form a non – electrolyte. (1mk)

24. State what would be observed when dilute hydrochloric acid is added to the products formed when a mixture of iron fillings and sulphur? (1mk)

25. Describe how the following reagents can be used to prepare lead sulphate solid potassium sulphate, solid lead carbonate, dilute nitric acid and distilled water.

26. Explain why the enthalpy of neutralization of ethanoic acid with sodium hydroxide is different from that of hydrochloric acid with sodium hydroxide. (2mks)

27. Give a reason why calcium hydroxide solution is used to detect the presence of carbon dioxide gas while sodium hydroxide is NOT?

28. A compound $\text{C}_4\text{H}_{10}\text{O}$ is oxidized by excess acidified potassium permanganate to form another compound $\text{C}_4\text{H}_8\text{O}_2$. The same compound $\text{C}_4\text{H}_{10}\text{O}$ reacts with potassium to produce hydrogen gas.

a) Draw the structural formula and name the compound $\text{C}_4\text{H}_{10}\text{O}$ (1mk)

- b) Write an equation for the reaction between potassium and compound $C_4H_{10}O$.

29. During the production of hydrogen iodide, hydrogen reacts with iodine according to the equation:
- $$H_2(g) + I_2(g) \rightleftharpoons 2HI(g); 52.0 \text{ kJ}$$

Explain how the following would affect the yield of hydrogen iodide:

- a) Increase in temperature
- b) Increase in pressure. (2mks)
30. a) 100gm of radioactive ${}_{91}^{233}\text{Pa}$ was reduced to 12.5g after 81 days.
Determine the half-life of Pa. (2mks)
- b) ${}_{91}^{233}\text{Pa}$ decays by beta emission. What is the mass number and Atomic number of the element formed? (1mk)

CHEMISTRY PAPER 233/1

KCSE 1996 QUESTIONS

1. In an experiment to study the diffusion of gases, a student set up the apparatus shown in diagram 1. After sometime the student noticed a change in the water level as shown in the diagram

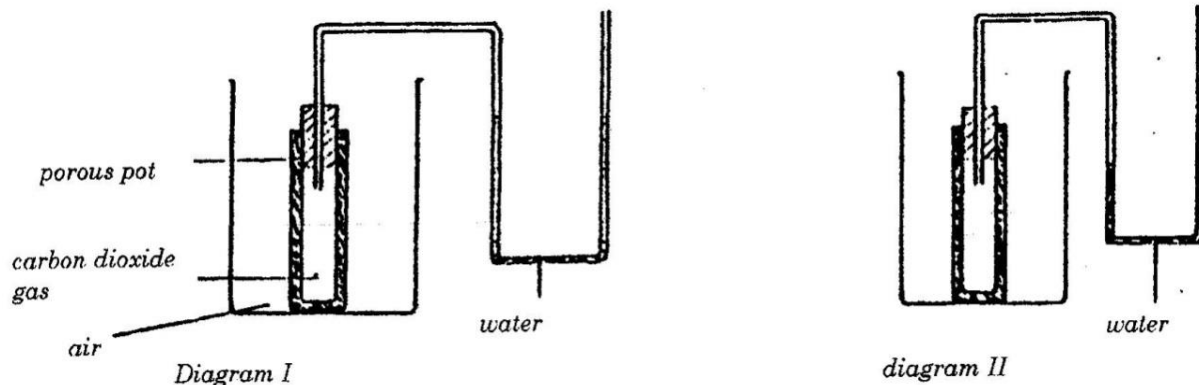

Give an explanation for the change in water level (2mks)

2. A fixed mass of a gas has a volume of 250cm^3 at a temperature of 27°C and 750mm Hg pressure. Calculate the volume the gas would occupy at 42°C (2mks)

3. Zinc metal and hydrochloric acid reacts according to the following equation

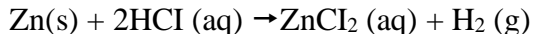

1.96 g of zinc were reacted with 100cm^3 of 0.2M hydrochloric acid

(a) Determine the reagent that was in excess

(b) Calculate the total volume of hydrogen gas was liberated S.T.P

(Zn= 65.4 Molar gas volume = 22.4 litres at S.T.P (1mk)

4. Ammonia can be converted to nitrogen monoxide as shown in the equation below

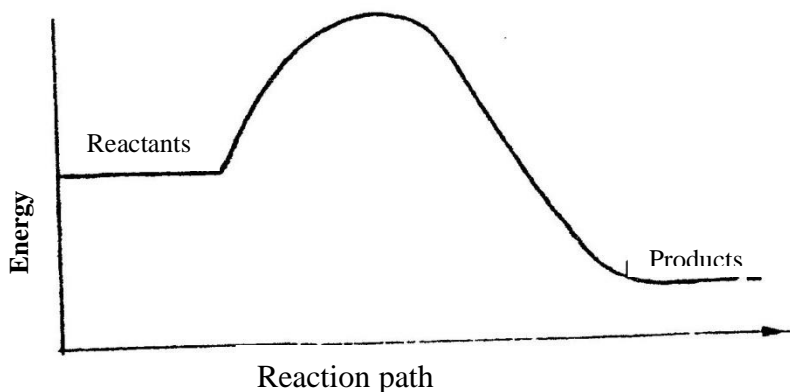
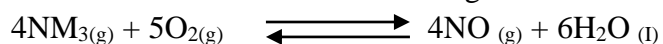

- (a) Explain how an increase in temperature would affect the yield of nitrogen monoxide (2mks)
- b) On the energy level diagram above sketch, the energy level diagram that would be obtained if the reaction is carried out in the presence of platinum catalyst. (1 mk)
5. a) Using dots(.) and crosses (x) to represent electrons draw diagram to represent the bonding in:
 (i) NH_3 (ii) NH_4^+ (1mk)
- b) State why an ammonia molecule (NH_3) can combine with H^+ to form NH_4^+ (Atomic numbers: $\text{N}=7$ and $\text{H}=1$) (1mk)
6. The table below shows some properties of substances E, F, G and H

Substance	Action with water	Melting point	Thermal conductivity
E	Un reactive	High	Poor
F	Reactive	High	Poor
G	Unreactive	High	Good
H	Unreactive	Low	Good

Select the substance that would be most suitable

- a) For making a cooking pot (1mk)
- b) As a thermal insulator (1 mk)
7. The reaction of propane with chlorine gas gave a compound of formula $\text{C}_3\text{H}_7\text{Cl}$.
 a) What condition is necessary for the above reaction to take place? (1mk)
 b) Draw two structural formulae of the compound $\text{C}_3\text{H}_7\text{Cl}$ (2mks)
8. A sample of air contaminated with carbon monoxide and sulphur dioxide was passed through the apparatus shown in the diagram below.

Air contaminated with $\text{CO}(\text{g})$ and $\text{SO}_2(\text{g})$

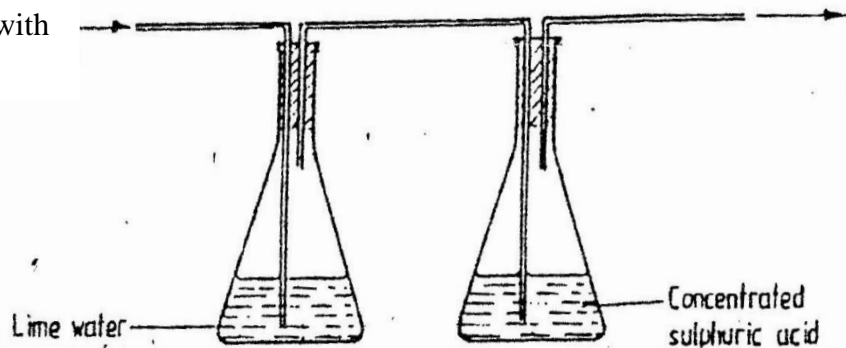

Lime water

Concentrated sulphuric acid

Which contaminant was removed by passing the contaminated air through the apparatus Explain . (2mks)

9. Explain how a sample of $\text{CH}_3\text{CH}_2\text{CH}_2\text{OH}$, could be distinguished from a sample of CH_3COOH by means of a chemical reaction (2mks)

10. A compound whose structure is shown below is found in a detergent.

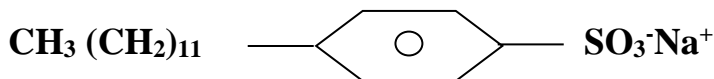

With reference to the structure, explain how the detergent removes grease during washing.

(2mks)

11. Complete the table below.

Species	Number of neutrons	Electrons
H		

12. When magnesium metal is burnt in air, it reacts with both oxygen and nitrogen gases giving a white ash. Write two equations for the reactions that take place. (2mks)

13. Methane reacts with oxygen as shown by the equations I and II below:

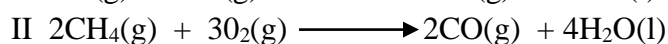
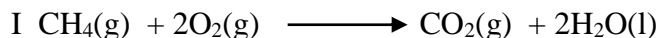

Which one of the two reactions represents the complete combustion of methane? Explain

(2mks)

14. The decomposition of calcium carbonate can be represented by the equation:

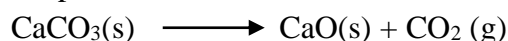

Explain how an increase in pressure would affect the equilibrium position (2mks)

15. The table below gives the atomic numbers of elements **W**, **X**, **Y**, and **Z**. The letters do not represent the actual symbols of the elements.

Element	W	X	Y	Z

Atomic Number	9	10	11	12
---------------	---	----	----	----

a) Which one of the elements is least reactive? Explain (1mk)

b) i) Which two elements would react most vigorously with each other? (1mk)

ii) Give the formula of the compound formed when the elements in b(i) react (1mk)

16. On strong heating, sodium nitrate oxygen gas. In the spaces provided below, draw a labeled diagram of a set-up that could be used for heating sodium nitrate and collecting the oxygen gas liberated. (3mks)

17. Oxygen reacts with the elements phosphorous, sulphur and chlorine to form oxides oxide of sulphur and its highest oxidation number. Complete the table for phosphorus and chlorine. (Atomic numbers: P=15, S= 16 Cl = 17)

Element	Oxide	Highest oxidation number
P	_____	_____
S	SO ₃	46
Cl	_____	_____

18. Explain why it is not advisable to use aqueous chloride solution as the salt bridge in the electrochemical cell formed between half cells, Pb²⁺(aq)/pb(s) E⁰ = 0.13V and CU²⁺(aq) + (aq)/CU²⁺(aq)/Cu²(s) E⁰=0.34V (2mks)

19. Use the information below to answer the questions that follow:

Equation	Enthalpy of formation
H ₂ (g) + ½ O ₂ (g) → H ₂ O (l)	ΔH1= -286 kJmol ⁻¹
C(s) + O ₂ (g) → CO ₂ (g)	ΔH2= 394kJmol
2C(s) + 3H ₂ (g) ½ O ₂ + → C ₂ H ₅ OH (i);	ΔH3=277kJmol ⁻¹

a) Define the term “enthalpy of formation of a compound (1mk)

b) Calculate the molar enthalpy of combustion, Δ H₃ of ethanol: C₂H₅OH (l) + 3O₂(g) → 2CO₂ (g) +3H₂O (l) (2mks)

20. Complete the diagram below to show how α and β particles from a radioactive source can be distinguished from each other. Label your diagram clearly (3mks)

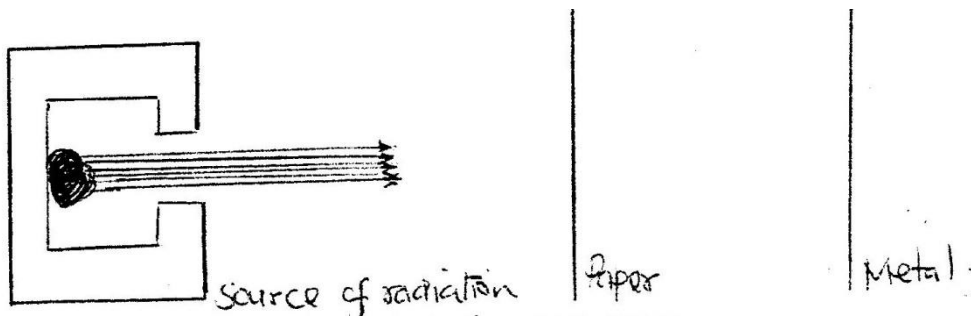

21. Chlorine and iodine are elements in the same group in the periodic table. Chlorine gas is yellow white aqueous, iodine; I₂(aq) is brown.
- What observation would be made if chlorine gas is bubbled through aqueous sodium iodide? Explain using and ionic equation. (2mks)
 - Under certain conditions chlorine and iodine react to give iodine chloride, ICl₃(s)-
What type of bonding would you expect to exist in iodine trichloride? Explain (1mk)

22. The diagram below represents a set-up that was used to react lithium with water study it and answer the questions that follow:

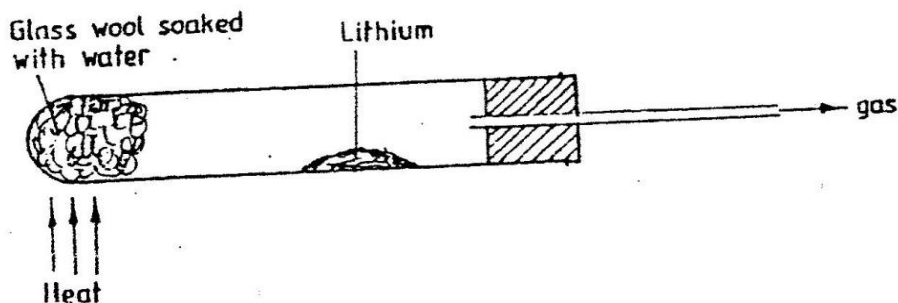

- Write an equation for the reaction that takes place; given that the atomic number of lithium is 3. (1 mk)
 - Why would it not be advisable to use potassium in place of lithium in the above set-up? (1mk)
23. Explain how you would obtain solid carbonate from a mixture of lead carbonate and sodium carbonate powders. (3mks)
24. In an experiment, 2.4g of sulphur was obtained by reacting hydrogen sulphide and chlorine as shown by the equation below:
- $$\text{H}_2\text{S}_{(g)} + \text{Cl}_{2(g)} \rightarrow \text{S}_{(s)} + 2\text{HCl}_{(g)}$$
- Which of the reactants acts as a reducing agent in the above reaction? Explain. (1 mk)

- (b) Given that the yield of sulphur in the above reaction is 75%, calculate the number of moles of $\text{H}_2\text{S}_{(g)}$ used in the reaction (S=32.0)

25. A polymer has the following structure:

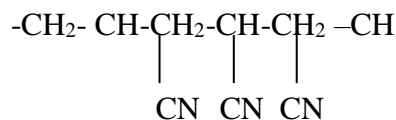

A sample of this polymer is found to have a molecular mass of 5194. Determine the number of monomers on the polymer (H=1.0, C= 12.0, N = 14.0)

26. Study the chart below and answer the questions that follow:

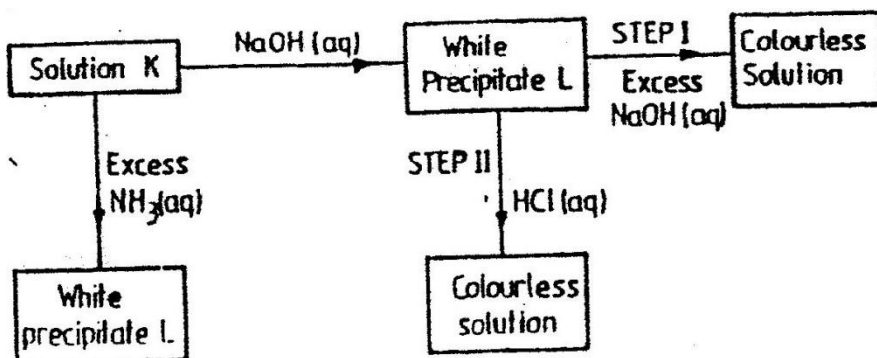

- a) Identify
- The metal ions in solution K (1mks)
 - The white precipitate L (1mk)

27. Study the flow chart below and answer the questions that follow

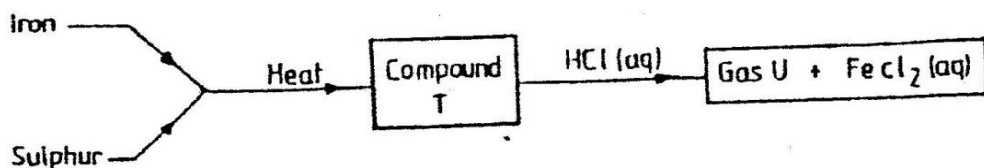

- a) Name
- Compound T (1mk)
 - Gas U (1mk)
- b) Give a chemical test that you could use to identify gas U (1mk)

28. A mixture of pentane and pentanoic acid was shaken with 0.1M sodium hydroxide solution and let to separate as shown in the diagram below:

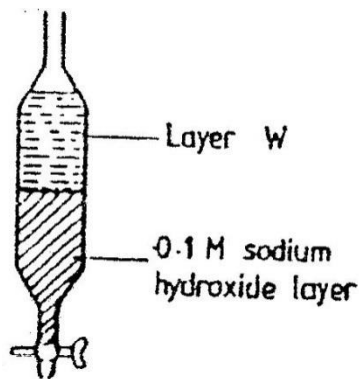

- Name the main component in layer W. Give a reason for the answer (2mks)
29. Write an equation for the reaction that takes place when carbon monoxide gas is passed over heated lead (II) oxide. (1mks)

CHEMISTRY PAPER 233/1
K.C.S.E 1997 QUESTIONS.

1. The set – up below was used to study some properties of air.

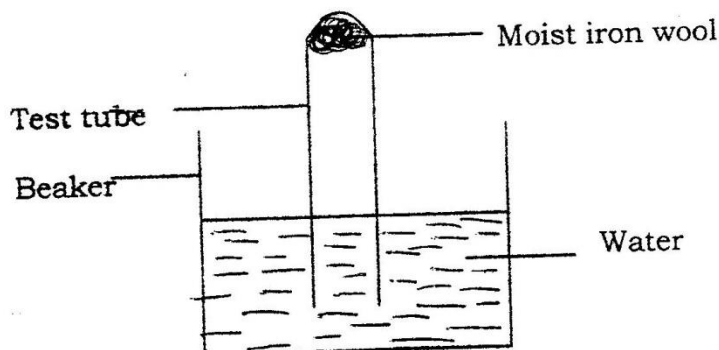

State and explain two observations that would be made at the end of the experiment.

2. When extinguishing a fire caused by burning kerosene, carbon dioxide is used in preference to water .Explain
3. Complete the table below by inserting the missing information in the space provided.

Name of polymer	Name of monomer	One use of the polymer
	Vinyl chloride (Chloroethane)	

4. When dilute nitric acid was added to a sample of solid C, a colourless gas that formed a white a white precipitate with limewater was produced. When another sample of solid C was heated strongly in a dry test – tube, there was no observable change.
5. The structure shown below represent two cleansing agents, A and B

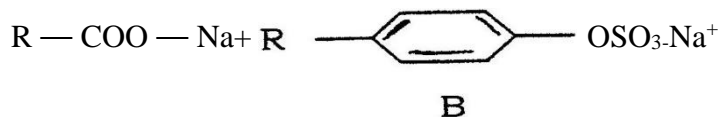

Which cleansing agent would be more suitable for washing in water containing magnesium sulphate?

Give a reason

6. Study the set – up below and answer the questions that follow.

Diagram

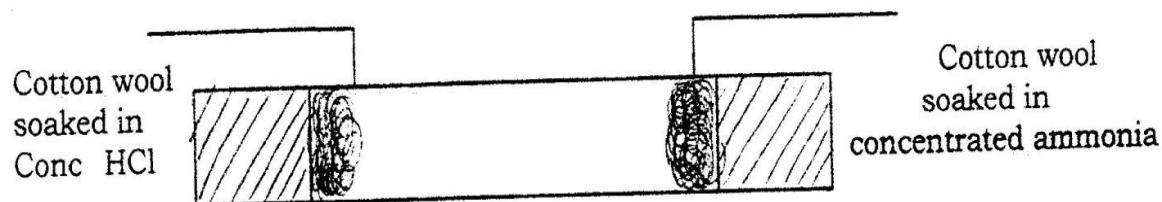

- a) What observation would be made in the tube?
- b) Indicate with a cross (x) on the diagram the likely position where the observation stated in (a) above would be made.
NB. Not to touch the cotton wool.
7. M grammes of a radioactive isotope decayed to 5 grammes in 100 days. The Half – life of the isotope is 25 days.
- a) What is meant by half – life?
- b) Calculate the initial mass of M of the radioactive isotope.
8. The empirical formula of a hydrocarbon is C_2H_3 . The hydrocarbon has a relative molecular mass of 54. (H = 1.0, C = 12.0).
- a) C_2H_3
- b) Draw the structural formula of the hydrocarbon
- c) To which homologous series does the hydrocarbon drawn in (b) above belong?
9. Potassium sulphite solution was prepared and divided into two portions. The first portion gave a white precipitate when reacted with barium nitrate. On addition of dilute hydrochloric acid the white precipitate disappeared.
- a) Write the formula of the compound which formed as the white precipitate.
- b) Write the equation for the reaction between dilute hydrochloric acid and the compound whose formula is written in (a) above.
- c) What observation would be made if one drop of potassium dichromate solution was added to the second portion followed by dilute hydrochloric acid?

10. 0.63g of lead powder were dissolved in excess nitric acid to form lead nitrate solution. All the lead nitrate solution was reacted with sodium sulphate solution.
- Write an ionic equation for the reaction between lead nitrate and sodium sulphate solutions.
 - Determine the mass of the lead salt formed in (a) above.
(Pb = 207, S = 32.0 = 16)
11. Explain why anhydrous magnesium chloride is fairly soluble in organic solvents while anhydrous magnesium chloride is insoluble.
12. Name and draw the structure of the compound formed when methane reacts with excess chlorine in the presence of U.V light.
13. Sulphur burns in air to form sulphur dioxide. A simple energy level diagram for the reaction is given below. Study the diagram and answer the questions that follow.

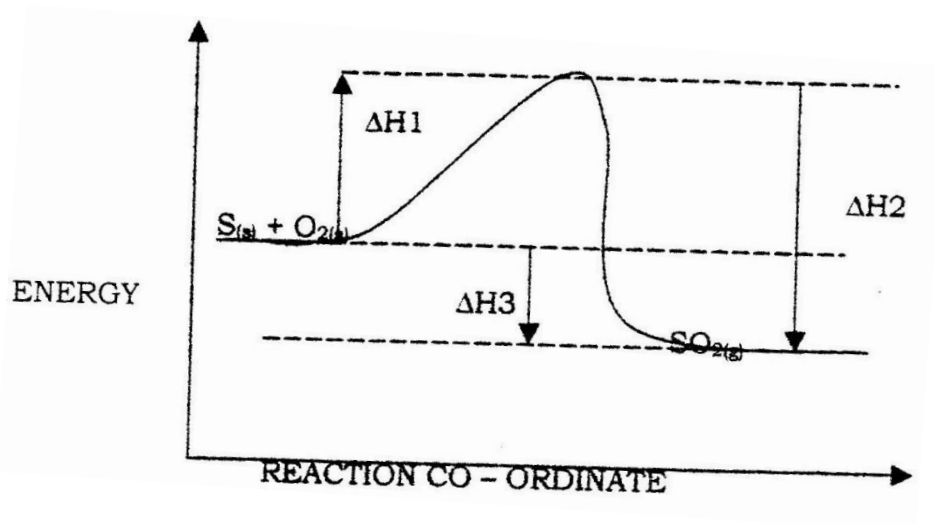

- What do the following represent?
- Write an expression, for ΔH_3 in terms of ΔH_1 and ΔH_2

14. In an experiment, chlorine gas was passed into moist hydrogen sulphide contained in a boiling tube as shown in the diagram

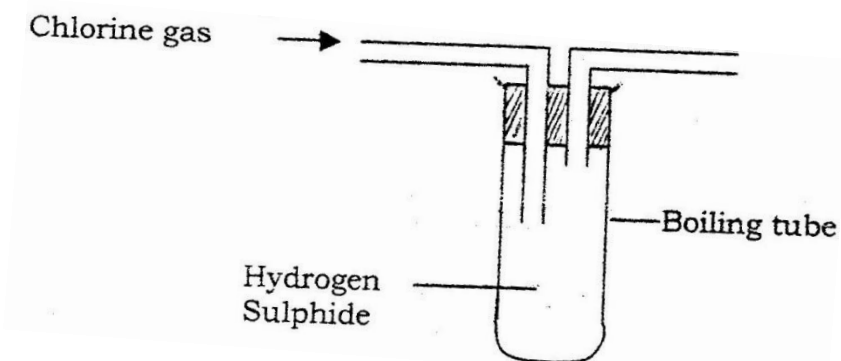

- What observation was made in the boiling tube?
 - Write an equation for the above reaction.
 - What precaution should be taken in carrying out this experiment? Give a reason.
15. Complete the diagram below to show how a sample of aqueous ammonia can be prepared in the laboratory.

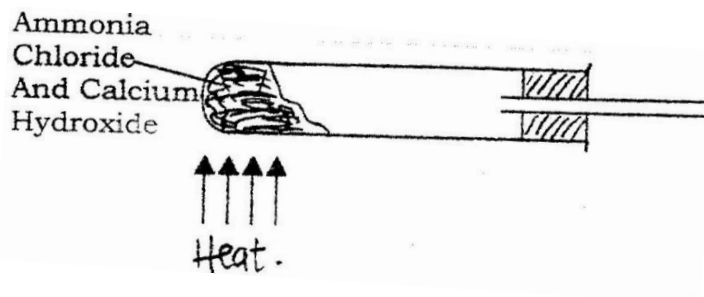

16. A gas occupies a volume of 400cm^3 at 500k and 1 atmosphere pressure. What will be the temperature of the gas when the volume and pressure of the gas is 100cm^3 and 0.5 atmospheres respectively.
17. In an equation below, identify the reagent that acts as abase. Give a reason.
 $\text{H}_2\text{O}_{(\text{aq})} + \text{H}_2\text{O}_{(\text{l})} \longrightarrow \text{H}_3\text{O}_{(\text{aq})} + \text{HO}^{2-}_{(\text{aq})}$

18. Study the scheme below and answer the questions that follow.

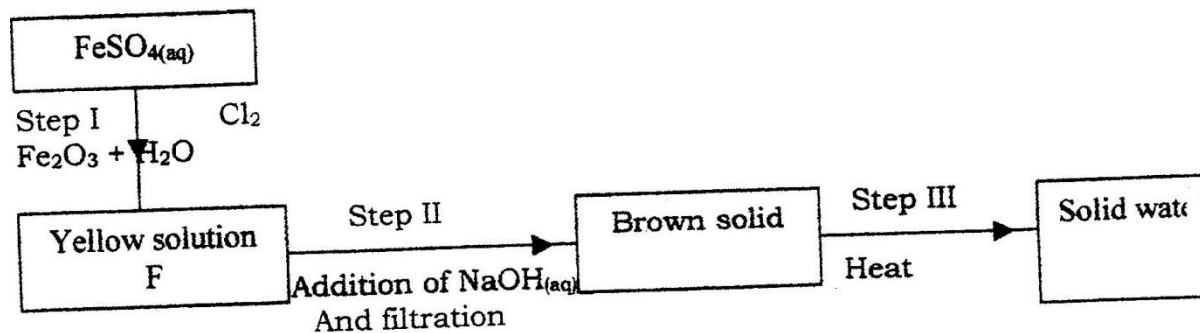

- a) Write the formula of the cation present in solution F.
- b) What property of chlorine is shown in step I
- c) Write an equation for the reaction which occurs in step III
19. 90cm^3 of 0.01M calcium hydroxide were added to a sample of water containing 0.001 moles of calcium hydrogen carbonate.
- a) Write an equation for the reaction which took place
- b) Calculate the number of moles of calcium ions in 90cm^3 of 0.01M calcium hydroxide.
- c) What would be observed if soap solution was added drop wise to a sample of the water after the addition of calcium hydroxide? Give a reason.
20. When 0.6g of element J were completely burnt in oxygen and all the heat evolved was used to heat 500cm^3 of water, the temperature of the water rose from 23°C to 32°C . Calculate the relative atomic mass of element J given that the specific heat capacity of water = $4.2\text{JK}^{-1}\text{g}^{-1}$, density of water = 1.0g/cm^3 and molar heat of combustion of J is 380KJmol^{-1}
21. A student set up the experiment below to collect gas K the glass wool was heated before heating the Zinc powder.

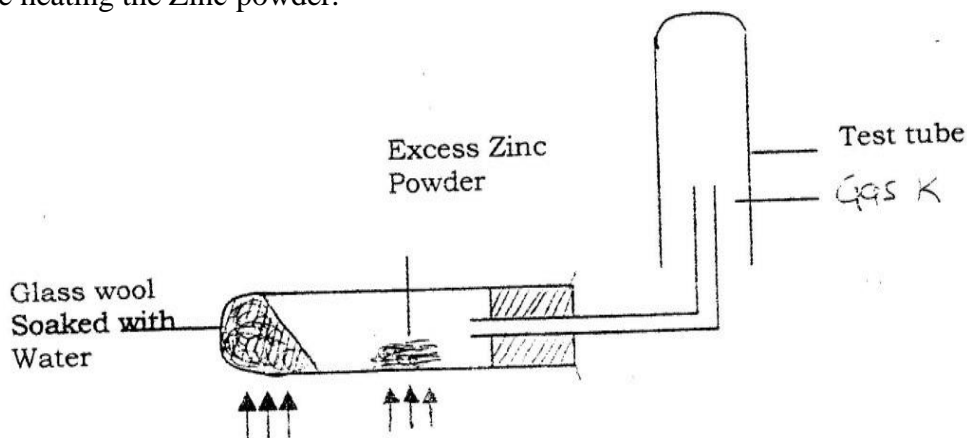

Why was it necessary to heat the moist glass wool before heating zinc powder

22. In an experiment to separate a mixture of two organic liquids, liquid M (b.p 56°C) and liquid N (b.p. 118°C), a student set up the apparatus shown below.

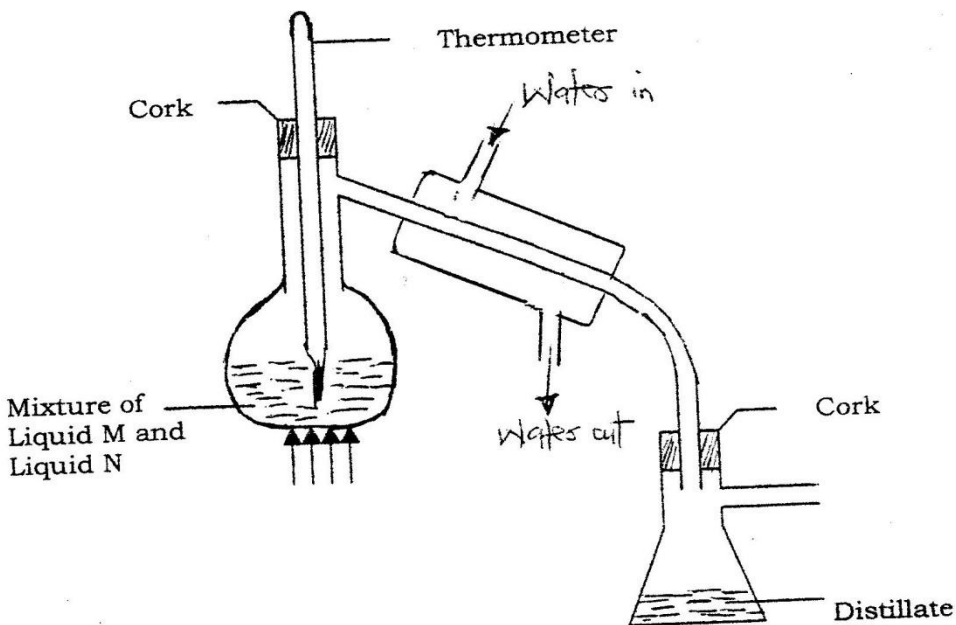

- a) Identify two mistakes in the set – up
- b) What method would the student use to test the purity of the distillates obtained?
23. An element Y has the electronic configuration 2.8.5
- a) Which period of the periodic table does the element belong?
- b) Write a formula of the most stable anion formed when element Y ionizes
- c) Explain the difference between the atomic radius of element Y and its ionic radius.
24. Aqueous potassium sulphate was electrolysed using platinum electrodes in a cell.
- a) Name the products formed at the cathode and anode.
- Anode
- b) How does the concentration of the electrolyte change during electrolysis.

- c) Why would it not be advisable to electrolyse aqueous potassium sulphate using potassium metal electrodes.

25. The information below relates to element L, Q,R and T.The letters do not represent the actual symbols of the elements. Arrange the elements in

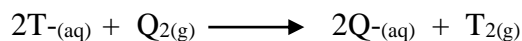

- a) Give the formula of an oxide which reacts with both dilute hydrochloric acid and hot concentrated sodium hydroxide.
- b) Give the formulae of the products formed when the oxide in (a) above reacts with excess hot concentrated sodium hydroxide.
26. Using dots (.)and crosses (x) to represent outermost electrons, draw diagrams to show the bonding in CO₂ and H₃O⁺ (Atomic numbers; H = 1.0,C= 14.0, O = 8).
27. Calculate the mass of nitrogen dioxide gas that would occupy the same volume as 10g of hydrogen gas at same temperature and pressure.(H = 1.0, N = 14.0, o = 16.0)

CHEMISTRY PAPER 233/ 1
K.C.S.E 1998 QUESTIONS

1. An isotope of Uranium ${}_{92}^{234}\text{U}$, decays by emission of an alpha particle to thorium
- Write the equation for the nuclear reaction undergone by isotope.
 - Explain why it is not safe to store radioactive substances in containers made from aluminium sheets.
2. Study the information in the table and answer the question below the table.

Substance	Solubility g /100g water
A	1.26×10^2
B	1.09×10^2

Describe how a solid sample of substance A could be obtained from a solid mixture of A and B.

3. Give one advantage and one disadvantage of using petrol containing tetraethyl lead in motor vehicles.
4. Use the information below to answer the questions that follow:
- | | | | | | |
|-----------------------------|---|-------------|-----------------------|----------------------|---------|
| $\text{Zn}^{2+}(\text{aq})$ | + | 2e | $\text{Zn}(\text{s})$ | \rightleftharpoons | -0.76 |
| $\text{Al}^{3+}(\text{aq})$ | + | 3e | $\text{Al}(\text{s})$ | \rightleftharpoons | 1.66 |
| $\text{Fe}^{2+}(\text{aq})$ | + | 2e | $\text{Fe}(\text{s})$ | \rightleftharpoons | -0.44 |

- a). Calculate the E value for the electrochemical cell represented bellow.

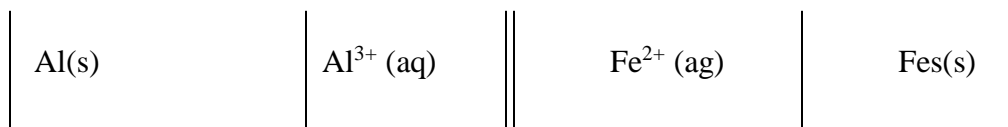

- b) Give a reason why aluminium metal would protect iron from rusting better than zinc metal.

5. The table below shows some properties of substances C, D and E. Study it and answer the questions that follow.

Substance	M.P (⁰ C)	Solubility in water	Electrical solid state	Conductivity molten stated.
E	-39	Insoluble	Good	good
D	1610	Insoluble	Poor	poor
E	801	Soluble	Poor	good

Select substance

- Within a giant molecular structure
 - That is not likely to be an element
6. On complete combustion of a sample of hydrocarbon, 3.52 gm of carbon dioxide and 1.44gm of water were formed. Determine the molecular formula of the hydrocarbon. (Relative molecular masses of hydrocarbon =56, carbon dioxide 44, water = 18 and relative atomic masses H = 1.0 and c=12.0)
7. A sample of water drawn from a river passing through an agricultural district was divided into two portions. The first portion gave a white precipitate when acidified barium chloride was added. The second portion when warmed with aqueous sodium hydroxide gave a colourless gas, which turned a moist red litmus paper blue.
- Identify the ions present in the river water.
 - Suggest the possible sources of the ions identified in (a) above.
8. The equation below represents a redox reaction. Identify the reducing agent. Give a reason. $2\text{FeCl}_2(\text{aq}) + \text{Cl}_2(\text{g}) \longrightarrow 2\text{FeCl}_3(\text{aq})$
9. (a) What is meant by dynamic equilibrium?
 (b) State and explain the observation that would be made if a few pellets of potassium hydroxide are added to the equilibrium mixture.
10. An ion of phosphorous can be represented as ${}_{15}^{31}\text{P}^{3-}$
 Draw a diagram to show the distribution of the electrons and the composition of the nucleus of the ion of phosphorous.

11. Diamond and graphite are allotropes of carbon. In terms of structure and bonding explain the following.
- Diamond is used in drilling through hard rocks
 - Graphite is used as a lubricant
12. Distinguished between a strong and a weak acid. Give examples.

13. The set-up below was used to electrolyze aqueous copper (II) sulphate

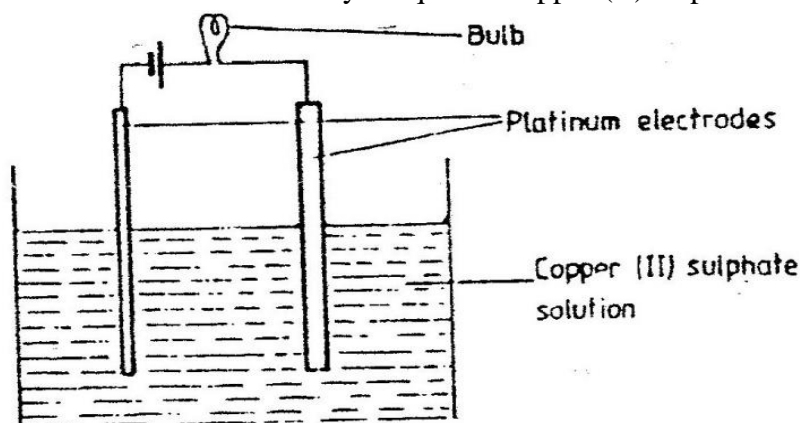

- Explain why the bulb light is brightly at the beginning of the experiment and becomes dim after sometime.
 - Write the ionic equation of the reaction that took place.
14. Draw the structural formula of:
- Ethanol
 - Propanoic
 - Give the name of the organic compound formed when ethanol and propanoic acid react in the presence of concentrated sulphuric acid.
15. The grid below shows part of a periodic table. The letters do not represent the actual symbols of the elements

													G				
F													H			I	

- a) Select the:
- element which has the largest atomic radius
 - Most reactive non-metal
- b) Show on the grid the position of the element J which forms J^{2+} ions with electronic configuration 2, 8, 8.

16. Study the information in the table below and answer the questions below the table.

Bond	Bond energy (kJmol^{-1})
C-H	414
Cl-Cl	244
C-Cl	326
H-Cl	431

Calculate the enthalpy change of the reaction:

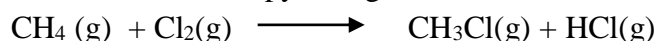

17. The diagram below represents a paper chromatogram for three brands of juices suspected to contain banned food colorings.

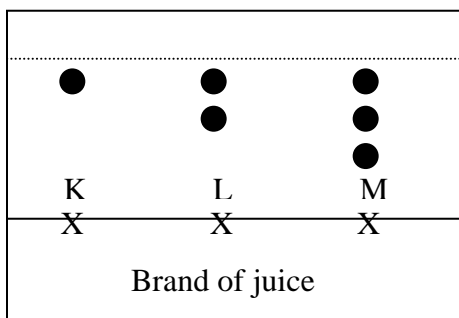

The results showed the presence of banned food colorings in L and M only. On the same diagram:

- Circle the spots which show the banned food colorings
- Show solvent front.

18. Urea, $(\text{NH}_2)_2\text{CO}$ is prepared by the reaction between ammonia and carbon dioxide.

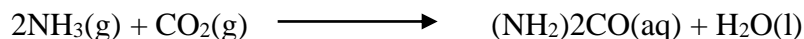

In one process, 680 kg of ammonia were reacted with excess carbon dioxide.

Calculate the mass of urea that was formed. (H = 1.0, C = 12.0, N = 14.0, O = 16.0 and relative molecular mass of ammonia = 17)

Calculate the mass of Urea that was formed

19. Describe how a solid sample of lead (II) Chloride can be prepared using the

following reagents, dilute nitric acid, dilute hydrochloric acid and lead carbonate.

20. The diagram below represents a charcoal burner. Study it and answer the questions that follow

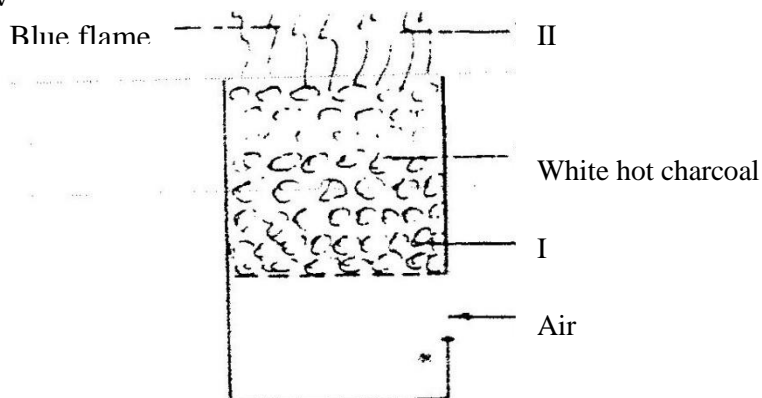

Write equations for the reactions taking place at I and I and II

21. The formula given below represents a portion of a polymer Give:

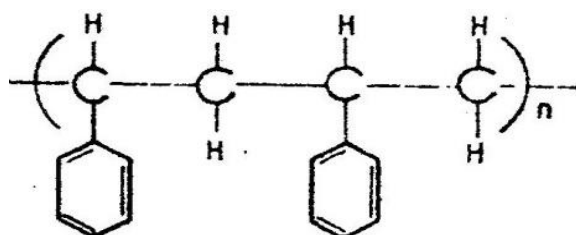

- The name of the polymer.
 - One disadvantage of continued use of this polymer.
22. The scheme below shows some reaction sequence starting with solid N.

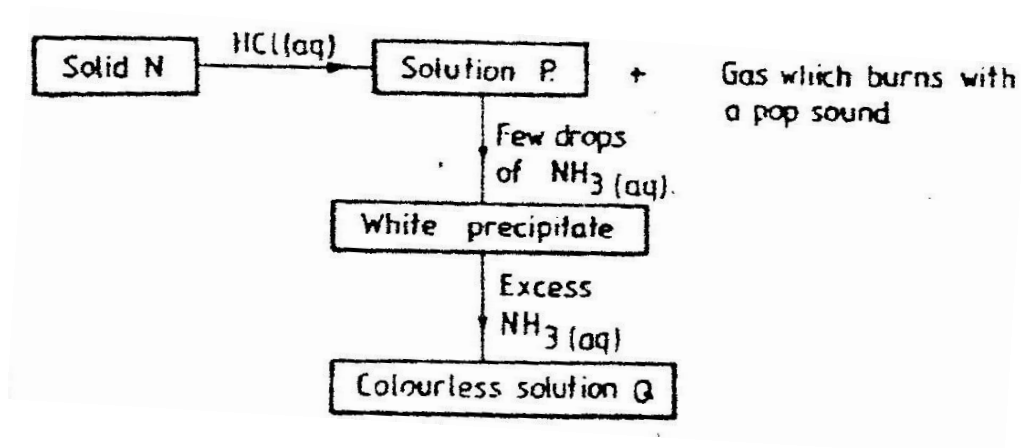

- Identify solid N

b) Write the formula of the complex ion present in solution

23. A sealed glass tube containing air at s.t.p was immersed in water at 1000c. Assuming that there was no increase in the volume of the glass tube due to the expansion of the glass, calculate the pressure of the inside tube. (standard pressure = 760mmHg,)
24. A beekeeper found that when stung by a bee, application of a little solution of hydrogen carbonate helped to relieve the irritation from the affected area. Explain.

25. The diagram below shows the physical state of matter. Study it and answer the questions that follow.

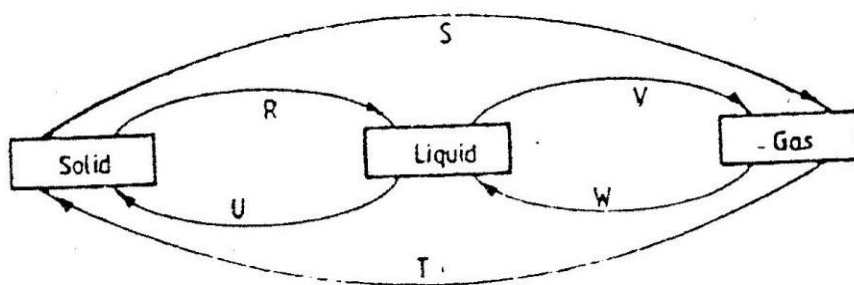

Identify the processes R, V, w and U

- (c) Name one substance which can undergo the process represented by S and T.

26. The table below gives the energy required to remove the outermost electron for some group I elements.

Element	I	II	III	IV
Energy kJmol^{-1}	494	418	519	376

Arrange the elements in order of their reactivity starting with the most reactive.

27. A hydrocarbon slowly decolorizes bromine gas in the presence of sunlight but does not decolourise acidified potassium permanganate.

Name and draw the structural formula of the fourth member of the series to

which the hydrocarbon belongs.

28. The column below was used do soften hard water

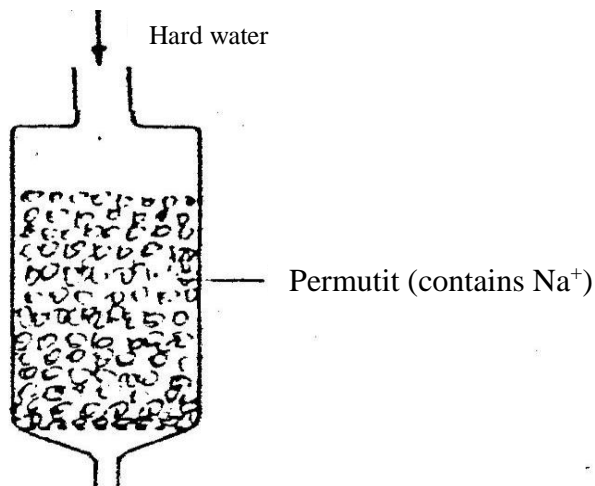

- (i) Explain how the hard water was softened as it passed through the column
 - (ii) After some time the material in the column is not able to soften hard water
How can the material be activated?
 - (iii) Give one advantage of using hard water for domestic purposes.
29. What is the oxidation number of chlorine in CO_4

CHEMISTRY PAPER 233/1
K.C.S.E 1999 QUESTIONS

1. Aluminium metal is a good conductor and is used for overhead cables. State any other two properties that make aluminium suitable for this use

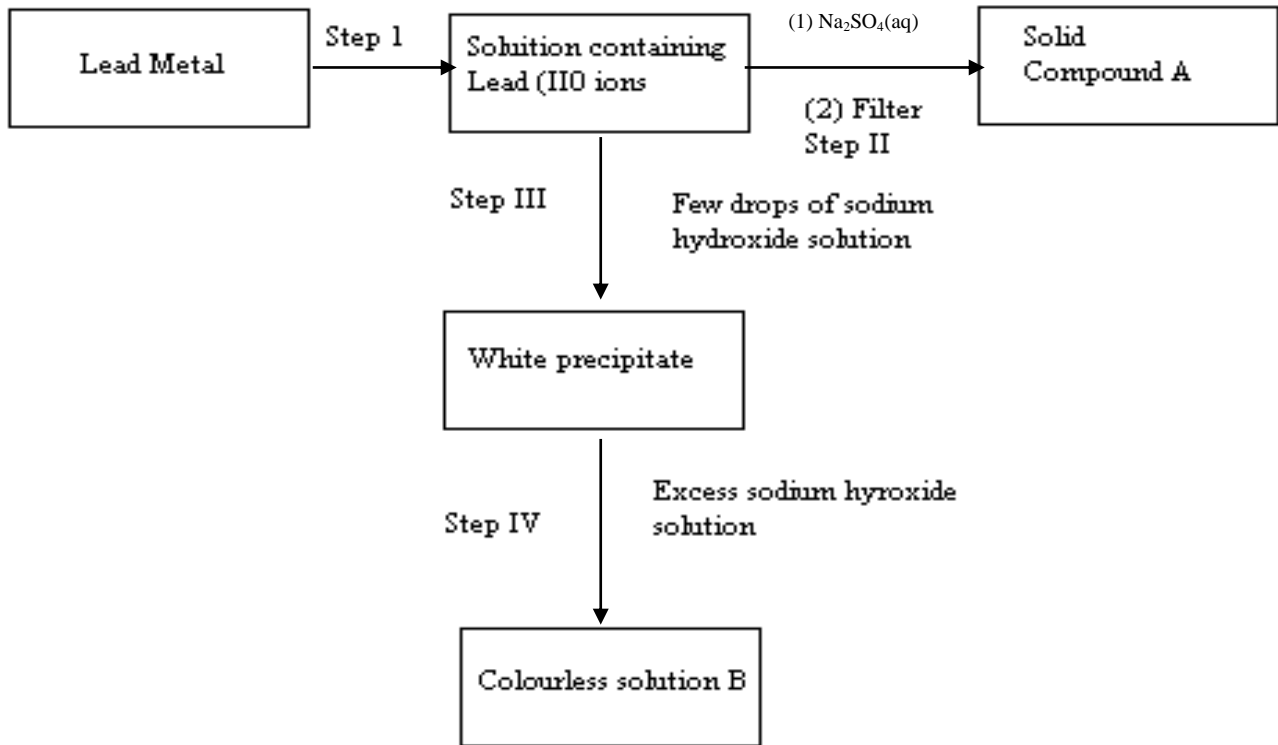

- (a) Name:
- (i) The reagent used in step I
 - (ii) Compound A
- (b) Write an ionic equation for the reaction in step IV
3. State and explain the observation that would be made when a few drops of concentrated sulphuric acid are added to a small sample of hydrated copper (II) sulphate
4. 4.76g of liquid ammonia and 4.76g of liquid nitrogen were each allowed to warm up and hang into gas at warm temperature and pressure. Relative atomic masses: $\text{H}=1.0$ and $\text{N}=14.0$. Using the data given above, explain which gas occupied the

greater volume

5. Sulphur dioxide and nitrogen dioxide react as shown in the equation below

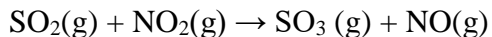

- (i) Using the oxidation numbers of either sulphur or nitrogen, show that this is a redox reaction
- (ii) Identify the reducing agent
6. What type of bond is formed when lithium and Fluorine react? Explain
(Atomic numbers: Li = 3 and F = 9)
7. Write the formula of sulphide of an element C, whose atomic number is 5. (C is not the actual symbol of the element)
8. The table below shows the solubility of a salt at various temperatures

Temperature ($^{\circ}\text{C}$)	Solubility g/ 100g W
0	36
40	30
80	25
110	20

What would happen if a sample of a saturated solution of the salt at 40°C is heated to 80°C . Explain

9. State the observation that would be made when a piece of sodium metal is placed in samples of:
- Pentane: _____
- Pentanol: _____

10. D gm of potassium hydroxide were dissolved in distilled water to make 100cm^3 of solution. 50cm^3 of the solution- required 50cm^3 of 2 M nitric acid for complete neutralization. Calculate the mass D, of potassium hydroxide

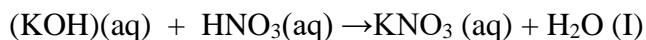

Relative formula mass of KOH = 56

11. In an attempt to prepare sulphur dioxide gas, dilute sulphuric acid was reacted with barium sulphuric. The yield of sulphur dioxide was found to be negligible explain

12. The curve below represents the changes in the concentration of substance E and F with time

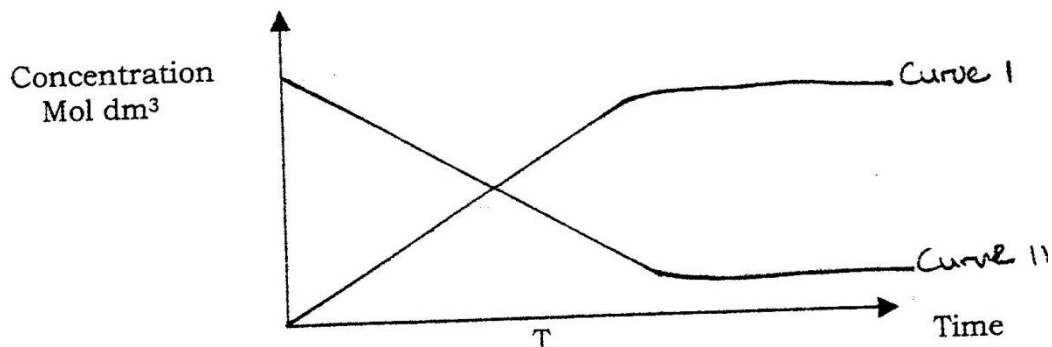

- Which curve represents the changes in concentration of substance F? Give a reason
- Give a reason for shapes of curves after time 't' minutes

13. Use the cell representation below to answer the questions that follow

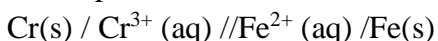

- Write the equation for the cell reaction
- If the E.M.F of the cell is 0.30 volts and the E^{θ} value for $Cr^{3+}/Cr(s)$

14. (a) A few drops of freshly prepared iron (II) sulphate solution were added to potassium nitrate solution in a test – tube. Concentrated sulphuric acid was then carefully added to the mixture. State the observation that were made

- Write an equation for the reaction that occurs when solid potassium nitrate is strongly heated



15. Use the information below to answer the question that follows

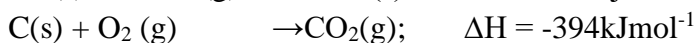

Calculate the enthalpy change for the reaction

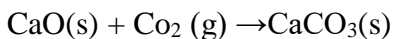

16. Under certain conditions, carbon dioxide reacts with water to form methanol (CH_3OH) and oxygen as shown below

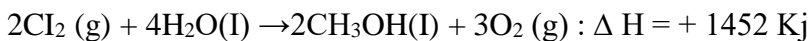

What would be the effect on the yield of methanol if the temperature of the reaction mixture is increased? Explain

In an experiment a certain volume of air was passed from syringe to syringe over heated zinc powder as shown in the diagram below

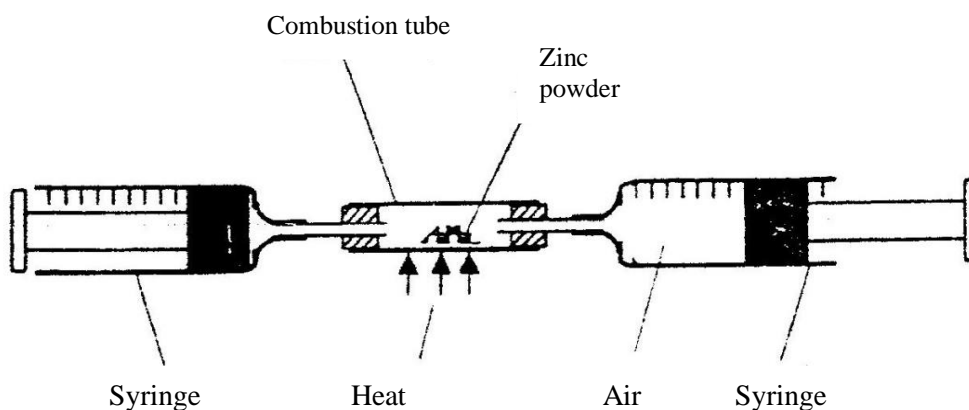

The experiment was repeated using excess magnesium powder. In which of two experiments was the change in volume of the air greatest. (Give reasons)

17. Use the information in the table below to answer the questions that follows

Element	Fluorine	Chlorine	Bromine	Iodine
Heat of vaporization	3.16	10.2	15.0	22.0

Explain the trend in the molar heats of vaporization

18. The diagram below shows a set up for the laboratory preparation and collection of dry chlorine gas

(a) Name

(i) Substance G

(ii) A suitable drying agent Conc.

- (b) What property of chlorine makes it possible for it to be collected as shown in the diagram?

19. The set up below was used to investigate some properties of two gases M and N

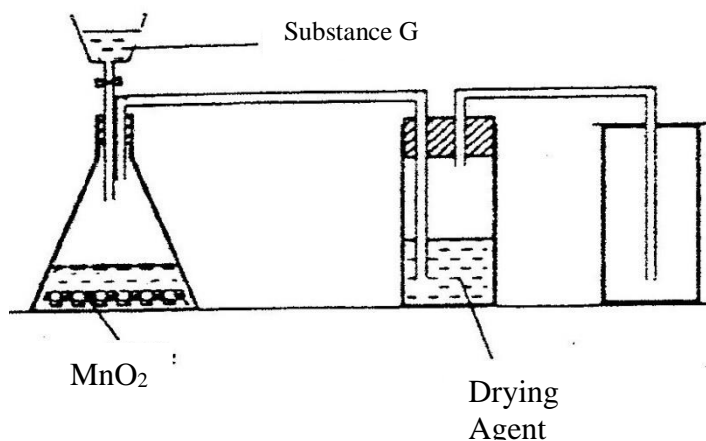

- a) Name
- (i) Substance G
 - (ii) A suitable drying agent conc.
- b) What property of chlorine makes it possible for it to be collected as shown in the diagram?

20. The set up below was used to investigate some properties of two gases M and N

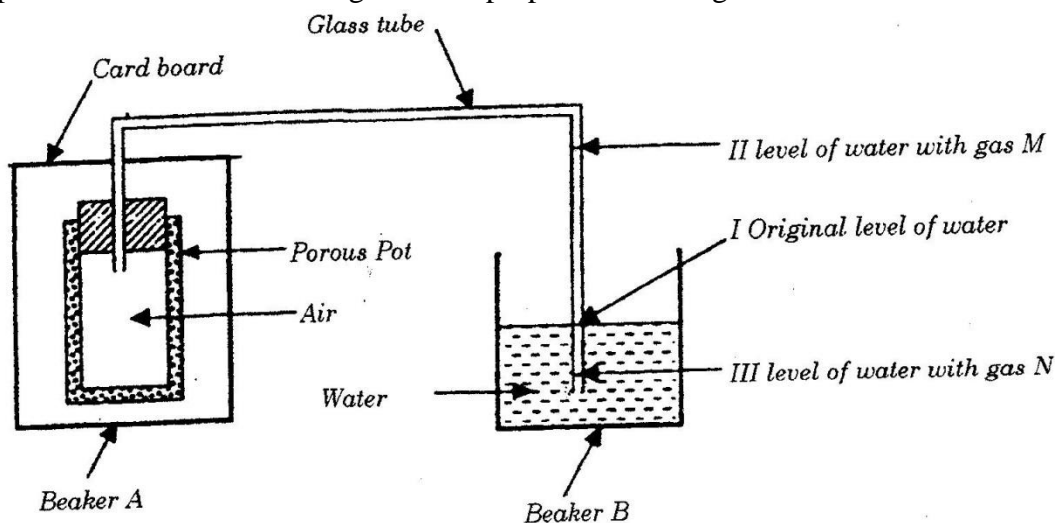

When beaker A was filled with gas M, the level of water in the glass tube rose to point II. When the experiment was repeated using gas N, the level of water dropped

to point III. Explain these observations.

21. State and explain one disadvantages of using hard water in boilers

22. Compound L reacts with hydrogen bromide gas to give another compound whose structure is

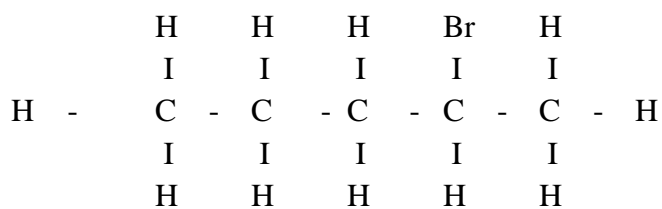

- (a) Give the structural formula and name of compound L
(b) Write an equation for the reaction, which takes place between ethane and excess chlorine gas

23. When excess carbon monoxide gas was passed over heated lead (II) oxide in combustion tube, lead (II) oxide was reduced

- (a) Write an equation for the reaction, which took place
(b) What observation was made in the combustion tube when the reaction was complete?
(c) Name another gas, which could be used to reduce lead (II) oxide

24. One of the fuels associated with crude oil is natural gas. Name the main constituent of natural gas and write an equation for its complete combustion

Name:

Equation:

25. When solid magnesium carbonate was added to a solution of hydrogen chloride in methylbenzene, there was no apparent reaction. On addition of water to the resulting mixture, there was vigorous effervescence. Explain these observations

26. The graph below shows the mass of a radioactive isotope plotted against time

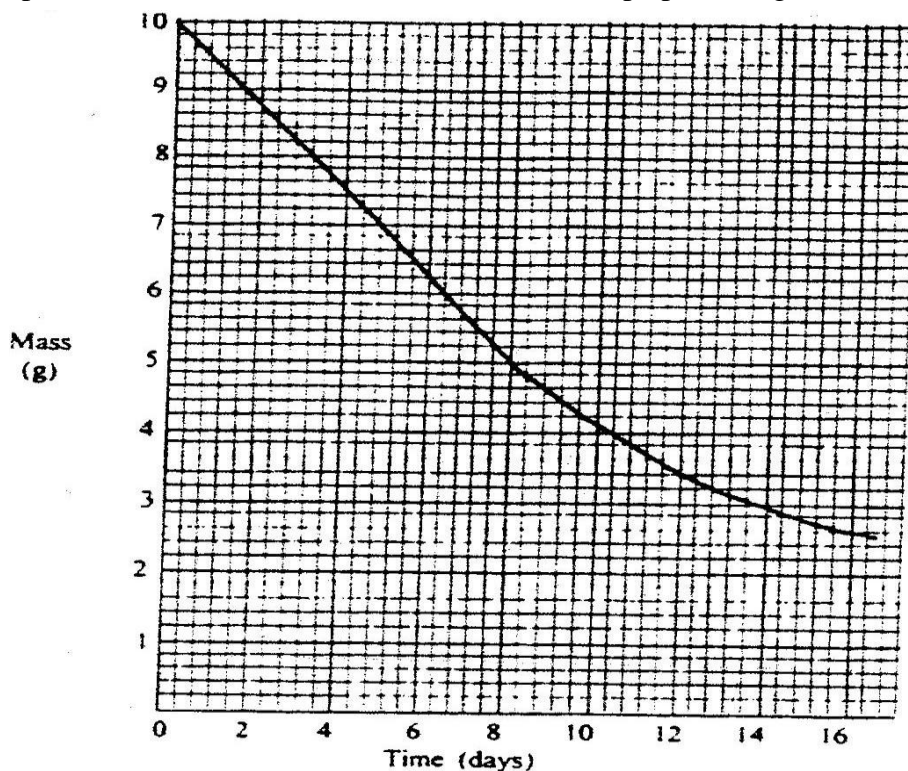

- Using the graph, determine the half – life of the isotope
- Calculate the mass of the isotope present after 32 days

27. The table below shows the P^H values of solutions I, II, III and IV.

Solution	I	II	III	IV
P ^H	2	7	11	14

- which solution is likely to be that of calcium hydroxide?
- Select the solution in which a sample of aluminium oxide is likely to dissolve. Give reason for your answer

28. Bromine reacts with ethane as shown below

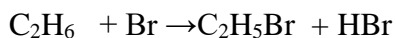

- What condition is necessary for this reaction to occur?
- Identify the bonds which are broken and those that are formed

Bonds broken

CHEMISTRY PAPER 233/1
K.C.S.E 2000 QUESTIONS

1. Explain the change in mass that occurs when the following substances are separately heated in open crucibles
- Copper metal
 - Copper (II) nitrate

2. The equation below represents a redox reaction

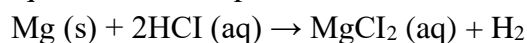

- Write down the equation for the reduction process
- Which substance is oxidized

3. The simplified flow chart shows some of the steps in the manufacture of sodium carbonate by the Solvay process

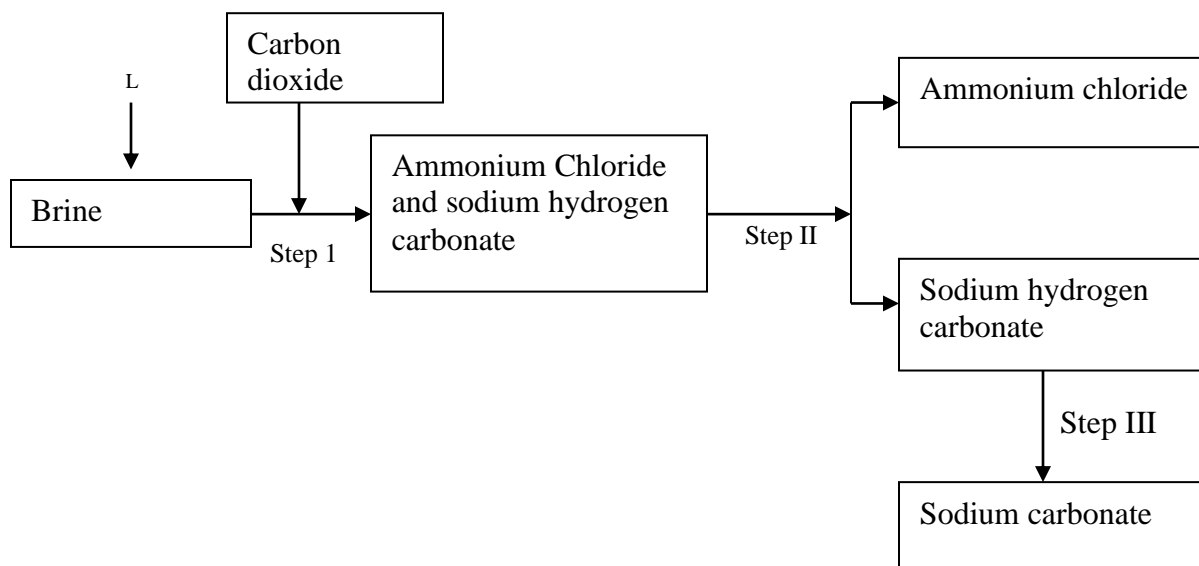

- Identify substance L
 - Name the process – taking place in step II
 - Write an equation for the reaction, which takes place in step III
4. When a current of 1.5 amperes was passed through a cell containing M^{3+} ions of a metal M for 15 minutes, the mass of the cathode increased by 0.26g.

(1 Faraday = 96500 coulombs)

- (a) Calculate the quantity of electricity used
- (b) Determine the relative atomic mass of metal M

5. The information below relates to elements S,T,U and X. (the letters do not represents the actual symbols of the elements.

- (i) T displaces X from an aqueous solution containing ions of X
- (ii) Hydrogen gas reduces heated oxide of S but does not reduce the heated oxide of X
- (iii) U liberates hydrogen gas from cold water but T does not

(a) Write an equation for the reaction between T and the ions of X.
(Both T and X are in group II of the periodic Table)

(b) Arrange the elements in order of their increasing reactivity

6. Starting with copper metal, describe how a solid samples of copper (II) carbonate can be prepared.

7. Give two reasons why helium is used in weather balloons

8. Study the solubility curves below and answer the questions that follows

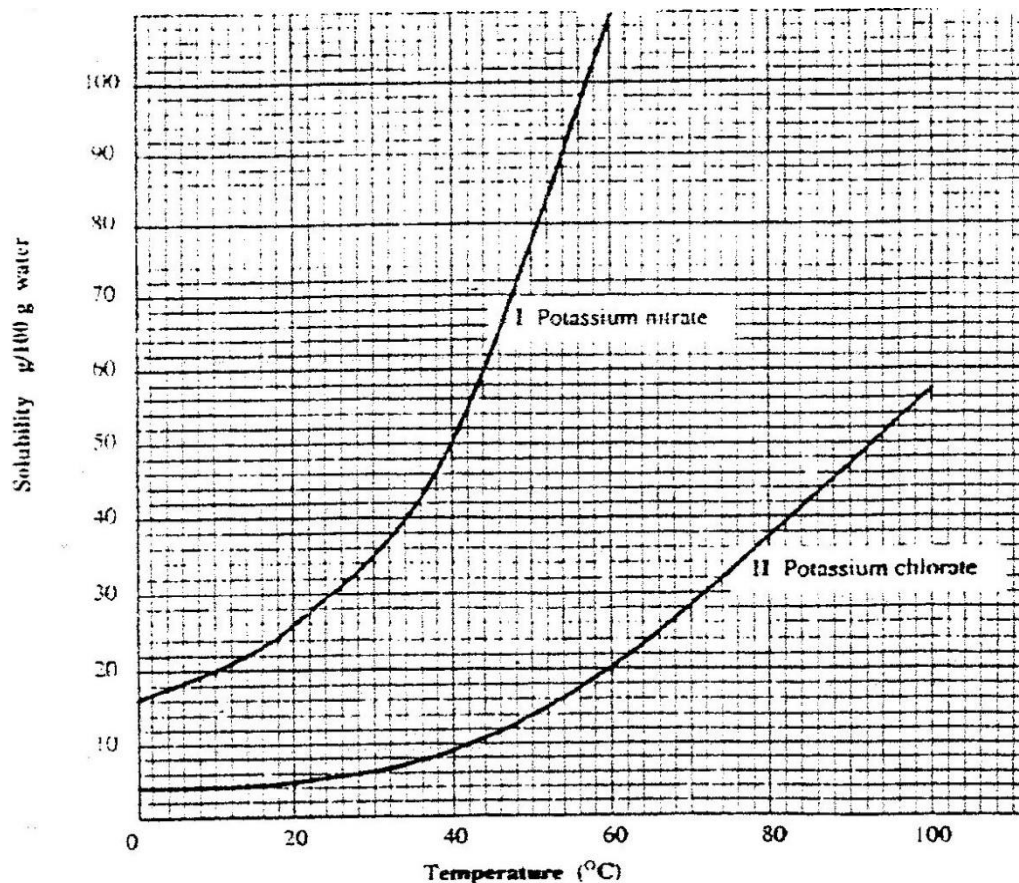

What happens when a solution containing 40gm of potassium chlorate and 40gm of potassium nitrate in 100gm of water at 90°C is cooled to 40°C ? Explain

9. A hydrocarbon P was found to decolourise bromine water. On complete combustion of 2 moles of P, 6 moles of carbon dioxide and 6 moles of water were formed

- Write the structural formula of P
- Give the name of P
- Name one industrial source of P

10. Use the scheme below to answer the questions that follow

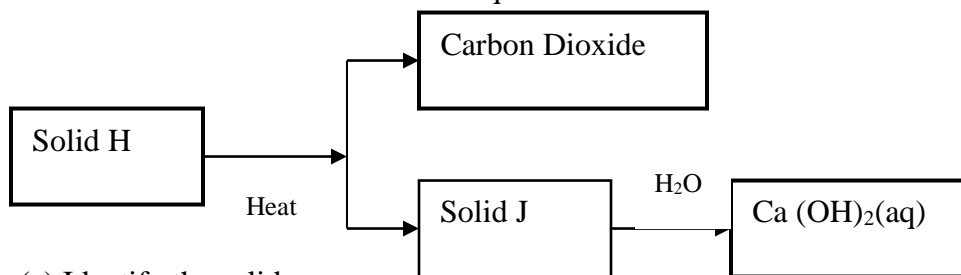

(a) Identify the solid

H

J

(b) State one commercial use of solid J

11. 20.0cm^3 of a solution containing 4 gm per litre of sodium hydroxide was neutralized by 8.0cm^3 of dilute sulphuric acid. Calculate the concentration of sulphuric acid in moles per litre (Na = 23.0, O = 16.0, H = 1.0)

12. A student set up the apparatus shown below to prepare ammonia gas and react it with copper (II) sulphate solution.

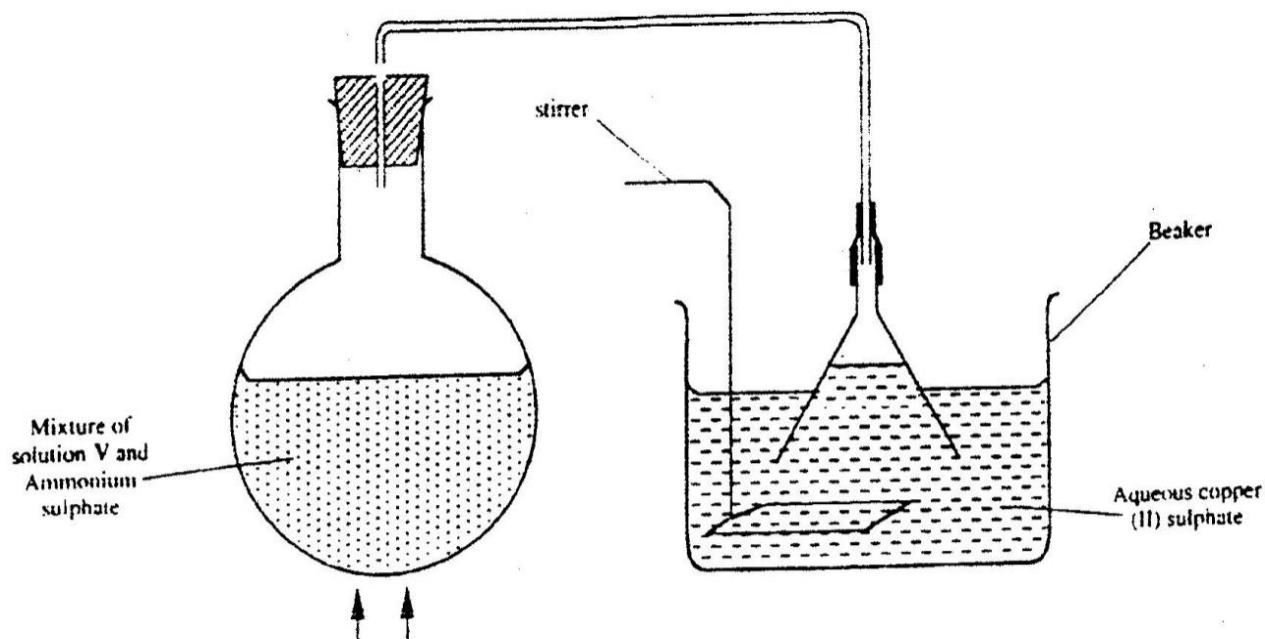

- (a) Identify solution V
- (b) State the observations which were made in the beaker

13. A radioactive isotope X_2 decays by emitting two alpha (α) particles and one beta (β) to form ${}_{83}^{214}\text{Bi}$

83

- (a) What is the atomic number of X_2 ?
- (b) After 112 days, $1/16$ of the mass of X_2 remained. Determine the half life of X_2

14. The table below shows the tests carried out on separate samples of water drawn from a well and the results obtained

Tests	Results
(i) Addition of excess aqueous	
(ii) Addition of a few drops of dilute sulphuric acid	
(iii) Addition of dilute hydrochloric acid followed by few drops of Barium chloride	

- (a) Identify the cation and the anion present in the water
 - Cation
 - Anion
- (b) Write an ionic equation for the reaction which takes place in test (iii)

15. State any two differences between luminous and non – luminous flames

16. Compound Q is a solid with a giant ionic structure. In what form would the Compound conduct an electric current

17. Study the set-up below and answer the questions that follow

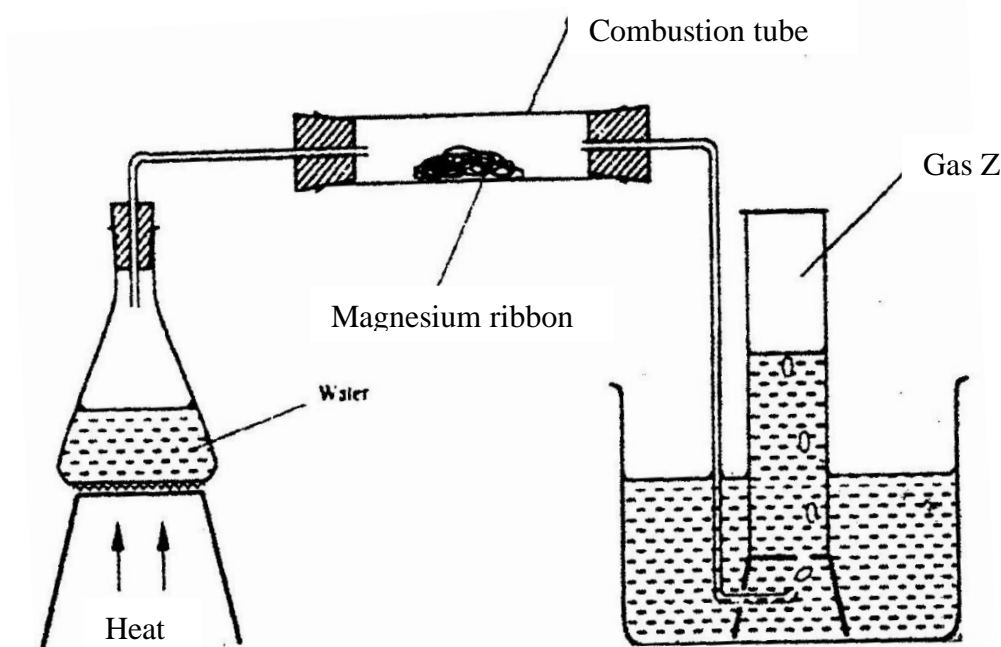

- (a) Write an equation for the reaction, which take place in the combustion tube
 (b) What property of gas Z allows it to be collected as shown in the diagram

18. A given volume of ozone, (O_3) diffused from a certain apparatus in 96 seconds. Calculate the time taken by an equal volume of carbon dioxide (CO_2) to diffuse under the same conditions ($O = 16.0$, $C = 12.0$)
19. The curves below were obtained when two equal volumes of hydrogen peroxide of the same concentration were allowed to decompose separately. In one case, manganese (IV) oxide was added to the hydrogen peroxide

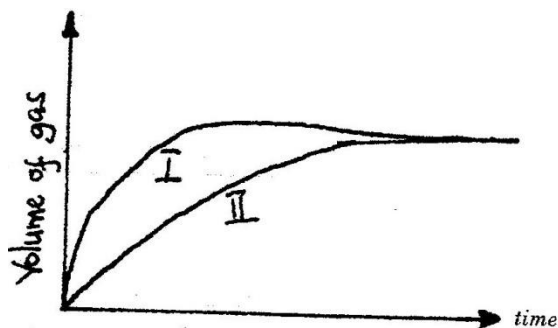

351439 for more Resources

Which curve represents the decomposition of hydrogen peroxide with manganese (IV) oxide? Explain

20. Pentane and ethanol are miscible. Describe how water could be used to separate a mixture of pentane and ethanol
21. Name another gas, which is used together with oxygen in welding
22. Study the information in the table below and answer the questions that follow. The letters do not represent the actual symbols of the elements)

Element	Electrical conductivity	Ductility	Action of water
A	Good	Good	No reaction
B	Good	Poor	No reaction
C	Good	Good	Reacts

Select an element which

- (a) Is likely to be used in group II of the periodic table
- (b) Could be used to make electric cables
- (c) Likely to be graphite

23. When a solid sample of sulphur is heated in a test tube, it changes into a liquid, which flows easily. On further heating, the liquid darkens and does not flow easily. Explain these observations.
24. Hydrogen and fluorine react according to the equation below
$$\text{H}_2(\text{g}) + \text{F}_2(\text{g}) \longrightarrow 2\text{HF}(\text{g}); \Delta\text{H} = -538\text{Kj}$$
- (a) On the grid provide below, sketch the energy level diagram for the forward reaction
- (b) Calculate the molar enthalpy of formation of HF
25. Explain why it is not advisable to leave a Jiko with burning charcoal in a closed room where one is sleeping.
26. In an experiment, ammonia chloride was heated in a test tube. A moist red litmus paper placed at the mouth of the test tube first changed blue then red. Explain these

observations

27. State and explain the function of tartaric acid in baking powder

CHEMISTRY PAPER 233/1
K.C.S.E 2001 QUESTIONS

1. Study the nuclear reaction given below and answer the questions that follow.

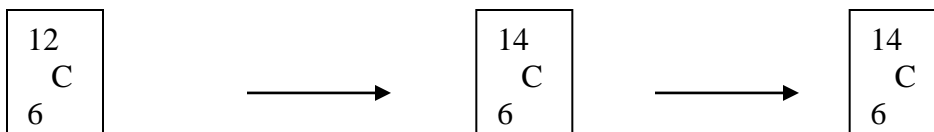

- (a) 12 and 14 are isotopes. What does the term isotopes. What does the term isotope mean?

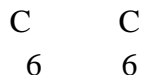

- (b) Write an equation for the nuclear reaction in step II

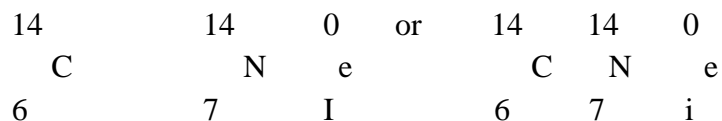

- (c) Give one use of $^{14}_6\text{C}$

2. In an experiment, 0.8gm of magnesium of powder were reacted with excess dilute sulphuric acid at 25°C . The time for the reaction to come to completion was recorded. The experiment was repeated at 40°C . In which experiment was the time taken shorter? Explain your answer.

3. The electronic structures for elements represented by letters A,B,C,D are

A=2 .8.6 B 2.8.2C 2. 8. 1 D 2. 8. 8.

- a) Select the element which forms:
(i) a double charged cation
(ii) A soluble carbonate
- b) Which element has the shortest atomic radius?

4. Study the scheme below and answer the questions that follow.

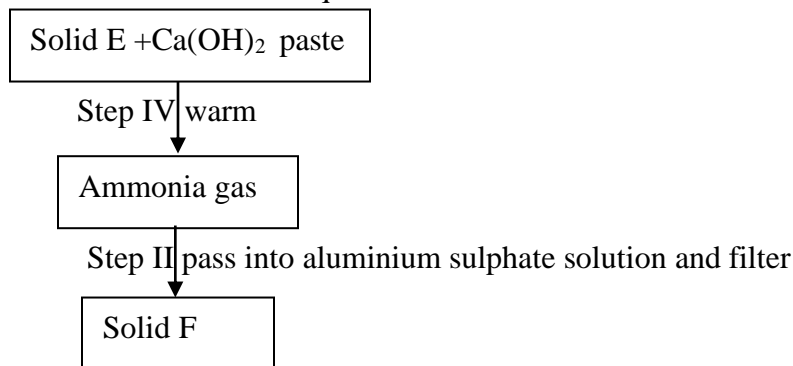

- a) Identify solid E.
- b) Write an ionic equation for the reaction in step II that produces solid F.
5. Give a reason why phosphorus is stored under water.
6. At 298K and 1 atmosphere, graphite changes into diamond according to the equation:
$$\text{C (graphite)} \longrightarrow \text{C(diamond)}; \Delta = 2.9 \text{ kJmol}^{-1}$$

In the space provided, sketch a simple energy level diagram for the above change.
7. How would you obtain a sample of pure iodine from a mixture of iodine and lead sulphate?
8. 10gm of sodium hydrogen carbonate were dissolved in 20cm³ of water in a boiling tube. Lemon juice was then added drop wise with shaking until there was no further observable change.
- a) Explain the observation, which was made in the boiling tube when the reaction was in progress
- b) What observation would have been made if the lemon juice had been added to copper turnings in a boiling tube? Give reason?
9. Sample solutions of salt were labeled as I, II, III and IV. The actual solutions, not in that order are lead nitrate, zinc sulphate potassium chloride and calcium chloride.
- a) When aqueous sodium carbonate was added to each sample separately, a white precipitate was formed in I, III and IV only. Identify solution II.
- b) When excess sodium hydroxide was added to each sample separately, a white

precipitate was formed in solutions III and I only.
Identify solution I

10. A weighed sample of crystalline sodium carbonate ($\text{Na}_2\text{CO}_3 \cdot \text{H}_2\text{O}$) was heated in a crucible until there was no further change in mass.
Calculate the number of moles (n) of the water of crystallization
11. A certain matchstick head contains potassium chlorate and sulphure.
On striking the two substances react to produce sulphure dioxide and potassium chloride. Explain the environmental effect of using such matches in large numbers.
12. Describe a simple laboratory experiment that can be used to distinguish between sodium and sulphide and sodium carbonate.
13. The information in the table below relates to elements in the same group of the periodic table. Study it and answer the question that follows:

Element	Atomic size
G1	0.19
G2	0.23
G3	0.15

Which element has the highest ionization energy? Give reason.

14. When the oxide of element H was heated with powdered carbon the mixture glowed and carbon dioxide was formed. When the experiment was repeated using the oxide of element J, there was no apparent reaction.
- a) Suggest one method that can be used to extract element J from its oxide
- b) Arrange the elements H, J and carbon in the order of their decreasing reactivity.
15. When a sample of concentrated sulphuric acid was left in an open beaker in a room for two days, the volume was found to have increased slightly
- a) What property of concentrated sulphuric acid was left in an open beaker in a room for two days, the volume was found to have increased slightly.
- b) State one use of concentrated sulphuric acid that depends on the property named above.

16. The diagram below shows an iron bar, which supports a bridge. The Iron bar is connected to a piece of magnesium metal.

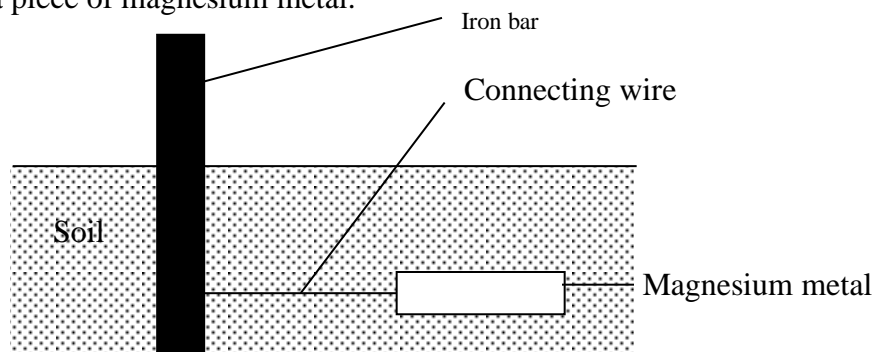

Explain why it is necessary to connect the piece of magnesium metal to the iron bar.

17. a) State one cause of temporary hardness in water.
b) How does distillation remove hardness from water?
18. In the presence of U.V light, ethane gas undergoes substitution reaction with chlorine.
(a) What is meant by the term?
Substitution reaction:

(b) Give the structural formula and the name of the organic product formed when equal volumes of ethane and chlorine react together.
19. Explain why burning magnesium continues to burn a gas was bubbled
20. a) what observation would be made if hydrogen sulphide gas was bubbled through a solution of zinc nitrate?

b) write an equation for the reaction that takes place in (a) above

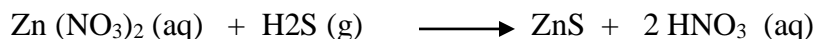

21. The apparatus shown below shown below was used to investigate the effect of carbon monoxide on copper (II)oxide.

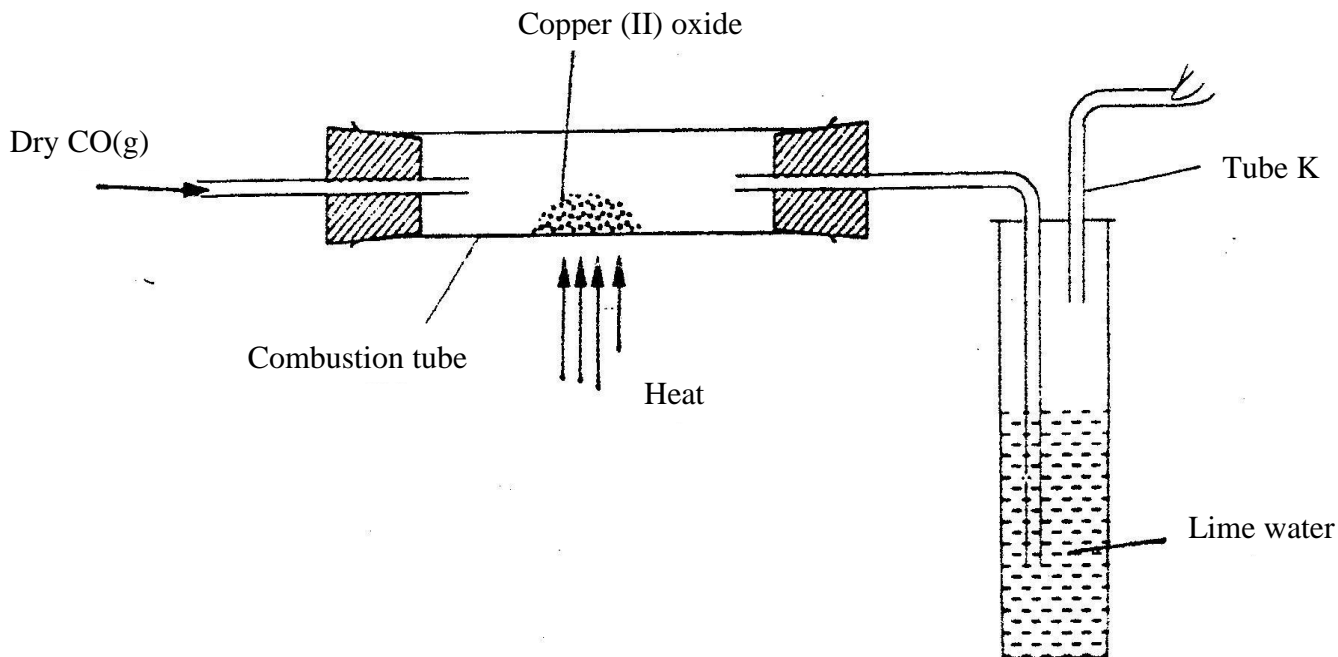

- State the observation that was made in the combustion tube at the end of the experiment.
 - Write an equation for the reaction that took place in the combustion tube
 - Why is it necessary to burn the gas coming out of tube K?
22. Explain why hydrogen forms compounds in which its oxidation state is either + 1 or -1 (Atomic number of hydrogen is 1)
23. The table below shows the properties of substances K,L,M and N

Substances	Reaction with oxygen at 25°C	Melting point	Conductivity Solid	Molten
K	Uncreative	Low	Poor	Good
L	Reactive			
M	Uncreative	High	Good	Good
N	Uncreative	Low	Good	Good

--	--	--	--	--

Select the substances which are likely to be:

- a) Copper metal
- b) Magnesium chloride

24. An element P has a relative atomic mass of 88. When a current of 0.5 amperes was passed through the fused chloride of P for 32 minutes and 10 seconds, 0.44g of P were deposited at the cathode. Determine the charge on an ion of P. (1 faraday = 96500 Coulombs).
25. The melting point of phosphorous dichloride is -91°C . While that of magnesium chloride is 715°C . In terms of structure and bonding, explain the difference in their melting points.
26. The Ph of a sample of soil was found to be 5.0. An agricultural office recommended the addition of calcium oxide in the soil. State two functions of the calcium oxide in the soil.
27. Hydrogen peroxide decomposes according to the equation below:

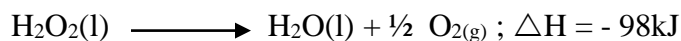

8.5 gm of hydrogen peroxide contained in 100cm^3 of solution with water were completely decomposed. Determine the rise in temperature due to the reaction. Specific density of water = 1g/cm^3 O = 16, H = 1).

CHEMISTRY PAPER 233/1
K.C.S.E 2002 QUESTIONS

1. Name One property of neon that makes it possible to be used in electric lamps
2. Oxygen and sulphur belong to group (VI) of the periodic table. Explain why there is a big difference their (melting points of oxygen is -216°C while that of sulphur is 44°C).
3. The oxides of elements A and B have the properties shown in the table below. (the letter do not represent the actual symbols of elements)

A	B
Gaseous at room temperature	Solid at room temperature
Dissolves in water to form an acidic solution	Dissolves in water to form an alkaline solution

Give one example of elements A and B

A

B

4. The following two tests were carried out on chlorine water contained in two test tubes
 - (a) A piece of blue flower was dropped into the first – tube. Explain why the flower was bleached
 - (b) The second test- tube was corked and exposed to sunlight after a few days, it was found to contain a gas that rekindled a glowing splint. Write an equation for the reaction which produced the gas
5. (a) Write the electronic configuration of calcium (atomic number 20) and beryllium (atomic number 4)
 - (b) Why is calcium more reactive than beryllium

6. When potassium nitrate is heated, it produces potassium nitrate and gas C₁
- Identify gas C
 - Name the type of reaction undergone by the potassium nitrate
7. State and explain how the rate of reaction between zinc granules and steam can be increased
8. The apparatus shown below was set to prepare and collect hydrogen sulphide

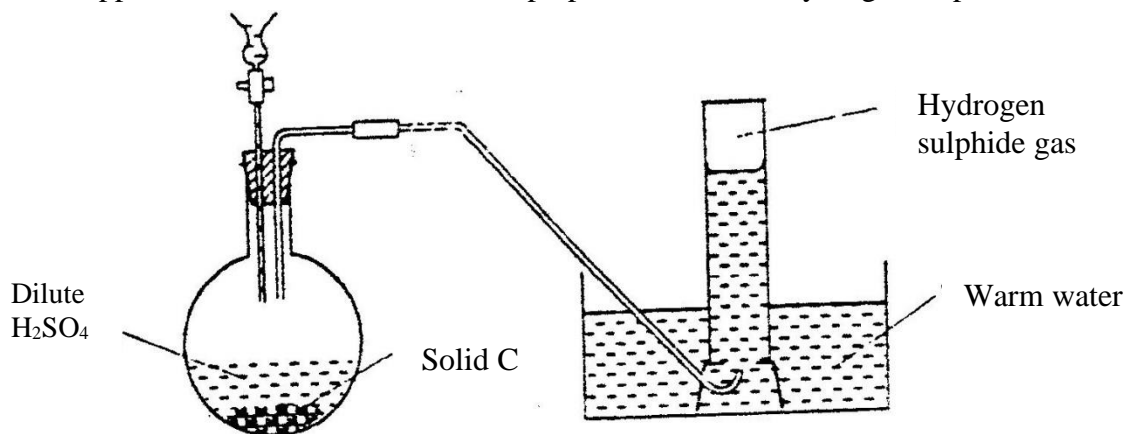

- Name solid C₂
 - Give a reason why warm water is used
 - What observation would be made if hydrogen sulphide gas was bubbled into a solution of lead II nitrate?
9. Use the reactions given below to answer the questions that follow. The letters do not represent the actual symbols of the elements
- $$D(s) + E^{2+}(aq) \rightarrow D^{2+}(aq) + E(s)$$
- $$D(s) + 2F^{+}(aq) \rightarrow D^{2+}(aq) + 2F(s)$$
- $$E(s) + 2F^{+}(aq) \rightarrow E^{2+}(aq) + 2F(s)$$
- $$G(s) + E^{2+}(aq) \rightarrow G^{2+}(aq) + E(s)$$
- $$G(s) + D^{2+}(aq) \rightarrow \text{no reaction}$$
- What name is given to the type of reaction given above?
 - Arrange the elements D, E, F and G in the order of their reactivity starting with the most reactive

(c) Complete the equation below

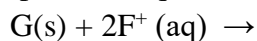

10. The graph below represents a radioactive decay series for isotope H. Study it and answer the questions that follow

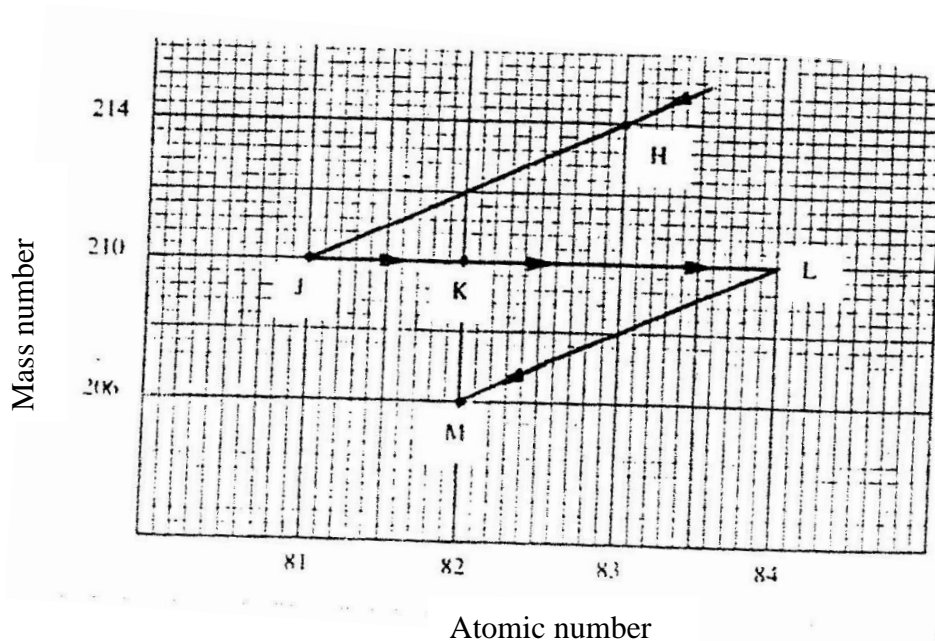

- (a) Name the type of radiation emitted when isotope H changes to isotope J.
 (b) Write an equation for the nuclear reaction that occur when isotope J changes to isotope K

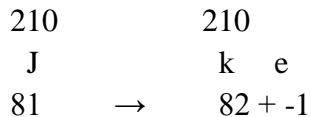

(c) Identify a pair of isotope of an element in the decay series

11. In an experiment, sulphur dioxide gas was bubbled into water followed by chlorine gas. The resulting clear solution gave a white precipitate when mixed with acidified barium chloride solution. Explain these observations

12. Concentrated sulphuric acid was added to iron II sulphate acidified with sulphuric acid and the mixture heated. The solution turned from pale green to yellow with evolution of brown gas. Explain these observations.

13. Use the equations below to answer the questions that follow

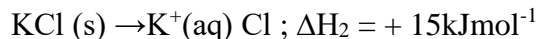
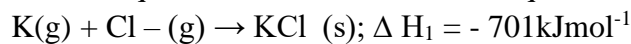

(a) What is the name of ΔH_1 ?

(b) Calculate the heat change for the process

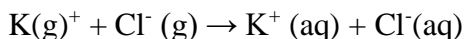

14. Iron is extracted from its ore by the blast furnace process

(a) Name one ore from which iron is extracted

(b) One of the impurities in iron is removed in the form of calcium silicate.

Write an equation for the reaction in which calcium silicate is produced

15. When carbon dioxide gas was passed through aqueous calcium hydroxide a white suspension was formed

(a) Write an equation for the reaction that took place

(b) State and explain the changes that would occur when carbon dioxide gas is bubbled through the white suspension

16. With reference to iodine, distinguish between covalent bonds and Van Der Waals forces

17. The structures below represents a portion of a polymer

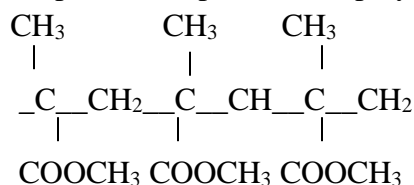

(a) Give the name of the polymer

(b) Give one industrial use of the polymer

18. Describe how a solid sample of Zinc (II) carbonate can be prepared starting with zinc oxide

19. Bismuth chloride (BiCl_3) reacts with water according to the equation given below

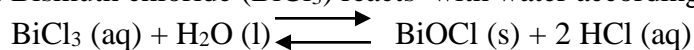

(a) State what would happen when a few drops of dilute hydrochloric acid are added

to the mixture at equilibrium

(b) Give a reason for your answer in (a) above

20. The table below gives some information about the electrical conductivity and the likely bonding in substances N,P and Q. Complete the table by inserting the missing information the spaces numbered I, II and III

Substance	Likely type of bonding present	Electrical solid	Conductivity
N	Metallic	I.....	Conducts
P	II.....	Does not conduct	Conducts
Q	III	Does not conduct	Does not conduct

21. In an experiment 30cm^3 of 0.1 M sulphuric acid were reacted with 30cm^3 of 0.1 M sodium hydroxide

- Write in equation of the reaction that took place
- State the observations that were made when both and red litmus papers were dropped into the mixture
- Give a reason for your answer in (a) above

22. The diagram below is set – up for the laboratory preparation of oxygen gas

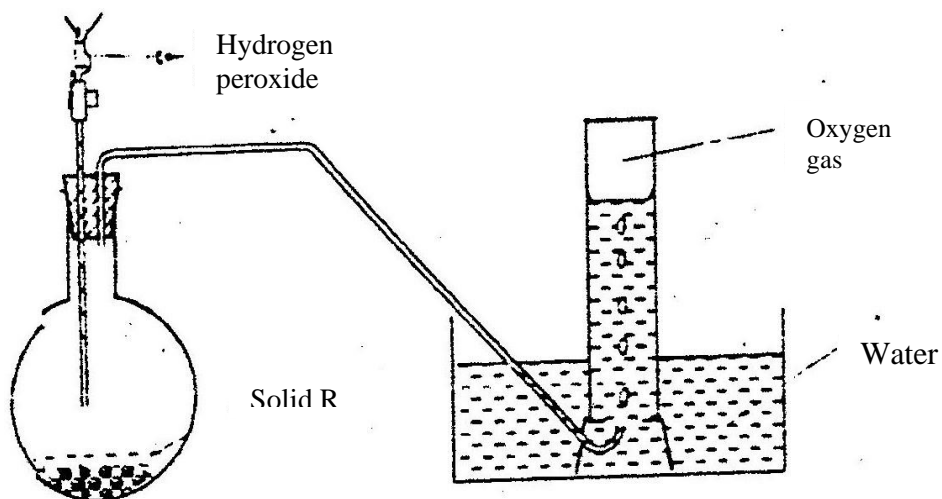

- Name solid R
- Write an equation for the reaction that takes place in the flask
- Give one commercial use of oxygen

23. When excess lead nitrate solution was added to a solution containing sodium

chloride, the precipitate formed was found to weigh 5.56 g.

Determine the amount of sodium chloride in the solution (Pb = 207, Cl = 35.5 Na = 23)

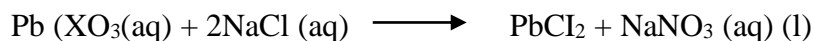

24. (a) Give a reason why concentrated sulphuric acid is not used to dry ammonia gas
(b) Name one suitable drying agent for ammonia gas

25. But -2- ene undergoes hydrogenation according to the equation given below

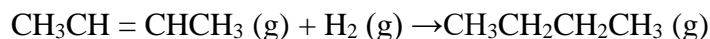

- (a) Name the product formed when but -2 - ene reacts with hydrogen gas
(b) State one industrial use of hydrogenation

26. The set – up below was used to electroplate a metallic spoon. Study it and answer the questions that follow

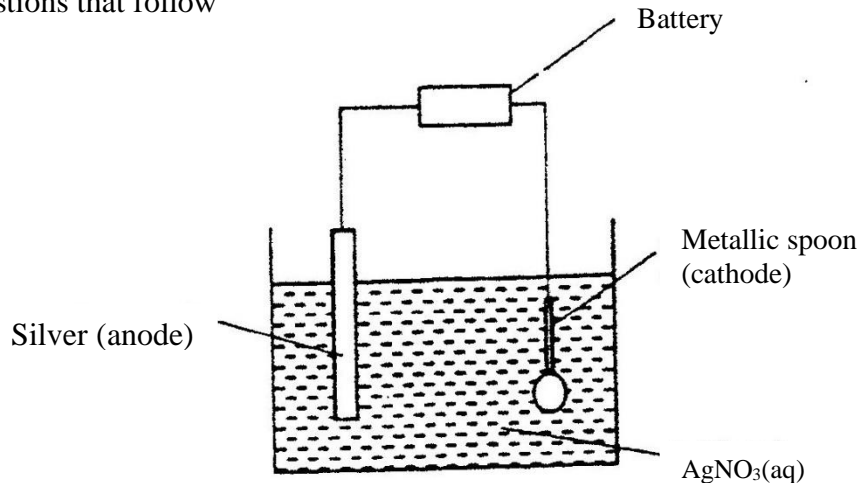

- (a) Write an ionic equation for the reaction that occurred at the cathode
(b) State and explain what happened to the anode

27. The following tests were carried out on three separate portions of a colourless solution S

Tests	Observations
(i) Addition of dilute hydrochloric acid to the first portion of solution	No observable change
(ii) addition of aqueous sodium carbonate to the second portion of solution S	A white precipitate was formed
(iii) Addition of aqueous ammonia to the third portion of a solution	A white precipitate was formed which dissolved on addition of excess aqueous ammonia

- (a) From the information in test (i), name a cation, which is not present in solution S.
- (b) Identify a cation, which is likely to be present in solution S
- (c) Write an ionic equation for the reaction, which takes place in test (ii)

CHEMISTRY PAPER 233 / 1
K.C.S.E 2003 QUESTIONS

- Some sodium chloride was found to be contaminated with copper (II) oxide. Describe how a sample of sodium chloride can be separated from the mixture
- Study the information in the table and answer the questions that follow

Ion	Electronic arrangement	Ionic radius
Na ⁺	2.8	0.095
K ⁺	2.8.8	0.133
Mg ²⁺	2.8	0.065

Explain why the ionic radius of K⁺ is greater than that of Na⁺ (1mk)

Mg²⁺ is smaller than that of Na⁺

- Use the following equations to determine the heat evolved when aluminum metal is reacted with iron (III) oxide (3 mks)

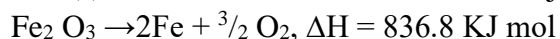
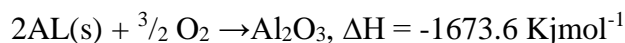
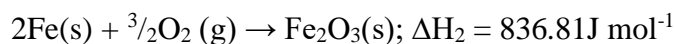
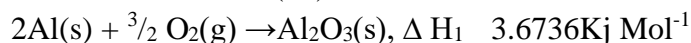

- (a) Sulphur exists in two crystalline forms
(b) Name one crystalline form of sulphur (1mk)

- An atom of hydrogen can form two ions. Write two equations to show how a neutral atom of hydrogen can form two ions. In each case show the sign of the energy change involved.

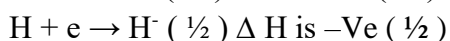
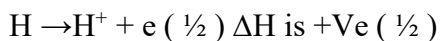

- When excess dilute hydrochloric acid was added to sodium sulphite, 960cm³ of sulphur (IV) oxide gas was produced. Calculate the mass of sodium sulphite

that was used. (molar mass of sodium = 126 g and molar gas volume = 24000cm³ (3mks)

7. In an experiment equal amounts of magnesium powder were placed into test – tube 1 and 2 as shown below

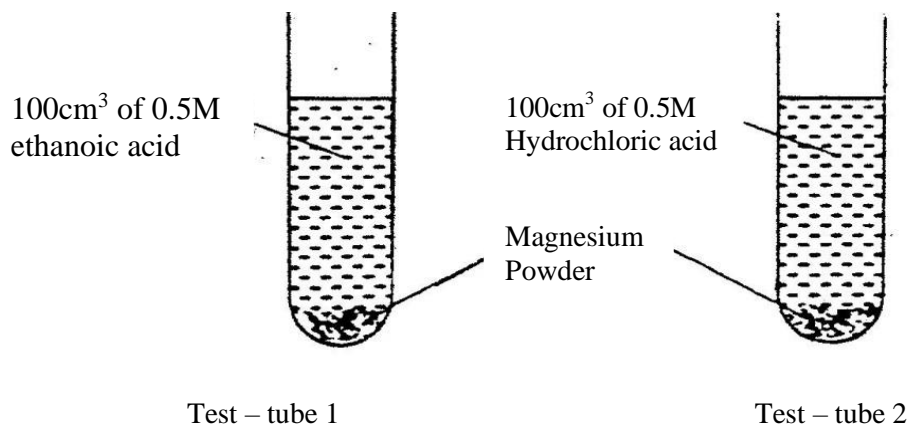

Explain why the amount of hydrogen gas liberated in test – tube 2 is greater than in test- tube 1 before the reaction is complete.

8. (a) what is meant by heat of vaporization (3 mks)
(b) The boiling points of ethanol, propanol and butanol are 78⁰C, 97.2⁰ and 117⁰C.
explain this trend (1 mk)
9. The set – up below represents the apparatus that may be used to separate a mixture of two miscible liquids C and D whose boiling points are 80⁰C and 110⁰C.

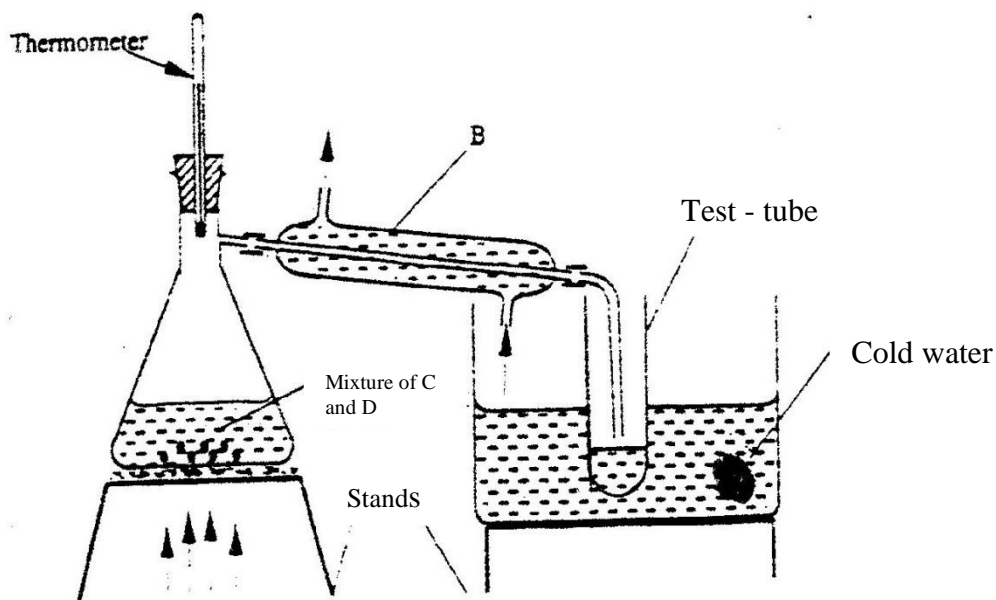

- (a) name B
 (b) What is the purpose of the thermometer (1mk)
 (c) Which liquid was collected in the test tube? (1mk)
10. An oxide of element F has the formula F_2O_5 (1 mk)
 (a) Determine the oxidation state of F
 (b) In which group of the periodic-table is element F (1mk)
11. Yellow phosphorous reacts with chlorine gas to form a yellow liquid. The liquid fumes when exposed to air. Explain these observations (2 mks)
12. When steam was passed over heated charcoal as shown in the diagram below, hydrogen and carbon monoxide gases were formed

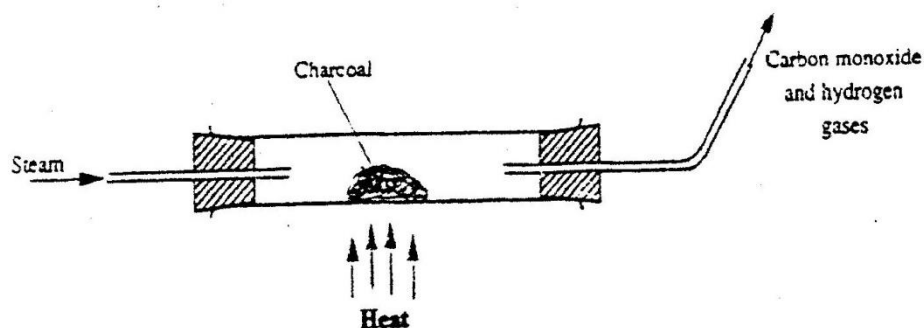

- (a) Write the equation for the reaction which takes place (1 mk)
 (b) Name two uses of carbon monoxide gas, which are also uses of hydrogen gas (2 mks)
13. Nitrogen (II) oxide and nitrogen (IV) oxide are some of the gases released from car exhaust pipes. State how these gases affect the environment
14. A few crystals of potassium permanganate were carefully placed into water in a beaker at one spot. The beaker was left undisturbed for two hours. State and explain the observation that was made. (2mks)
15. Oleum ($H_2S_2O_7$) is an intermediate product in the industrial manufacture of sulphuric acid
 (a) How is oleum converted into sulphuric acid? (1 mk)
 (b) Give one use of sulphuric acid (1mk)

16. Air was passed through several reagents as shown in the flow chart below

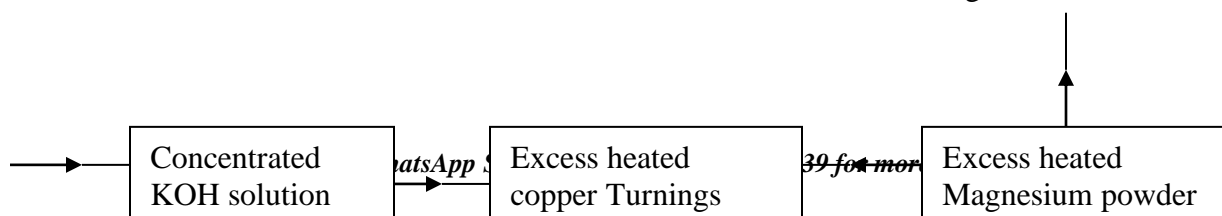

- (a) Write an equation for the reaction, which takes place in chamber with magnesium powder
- (b) Name one gas, which escapes from the chamber containing magnesium powder. Give a reason for your answer. (2mks)

17. Ammonium nitrate was gently heated and the products collected as shown in the diagram below.

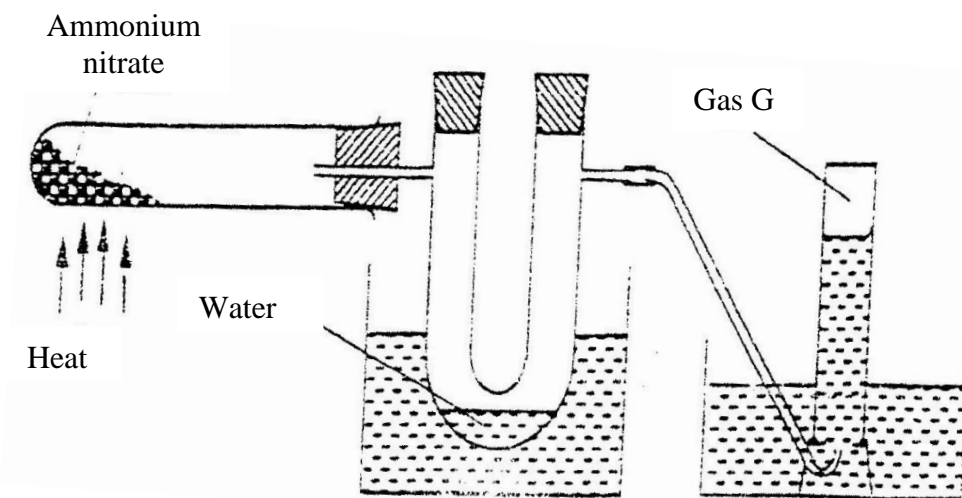

Describe one chemical and one physical method that can be used to identify gas G.

18. The table below shows the tests carried out on a sample of water and the results obtained.

	Tests	Results
I	Addition of sodium hydroxide solution	White precipitate which dissolves in excess
II	Addition of excess aqueous ammonia	Colourless solution obtained
III	Addition of dilute hydrochloric acid and barium chloride	White precipitate

- a) Identify the anion present in the water
- b) Write an ionic equation for the reaction in III
- c) Write the formula of the complex ion formed in II
19. In the Haber process, the optimum yield of ammonia is obtained when a temperature of 450°C , a pressure of 200 atmospheres and an iron catalysts are used



(a) How would the yield of ammonia be affected if the temperature was raised to 600°C? (2mks)

(b) Give one use of ammonia (1mk)

20. Brass is an alloy of zinc and copper. Give one use of brass (1mk)

21. An organic compound with the formula $\text{C}_4\text{H}_{10}\text{O}$ reacts with potassium metal to give hydrogen gas and white solid

(a) Write the structural formula of the compound

(b) To which homologous series does the compound belong?

(c) Write the equation for the reaction between the compound and potassium metal (1mk)

22. The set-up below was used to prepare hydrogen chloride gas and react it with iron powder. Study it and answer the questions that follow.

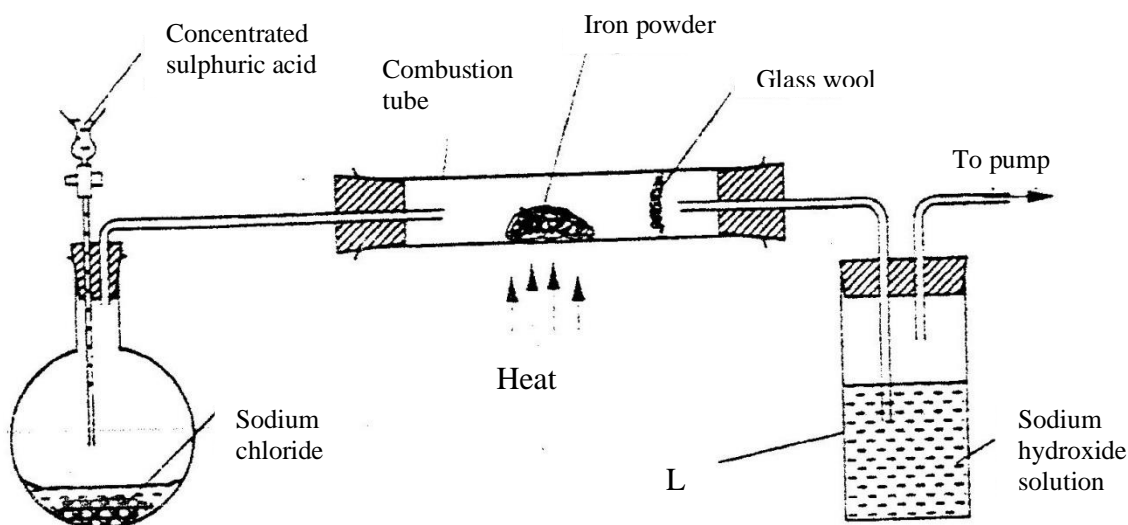

At the end of the reaction, the iron powder turned into a light green solid.

a) Identify the light green solid. (1mk)

b) At the beginning of the experiment, the Ph of the solution in container L was about 14. At the end, the pH was found to be 2. Explain (2mks)

23. a) State the observation made when excess pentane is reacted with bromine gas

b) Name the compound formed in (a) above. (1mk)

24. Explain why the reactivity of group (vii) elements decreases down the group

25. The graph below shows the behaviour of a fixed mass of a gas at constant temperature.

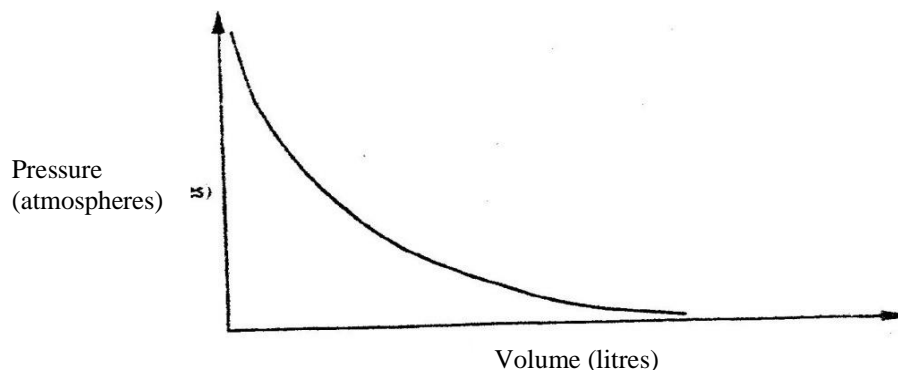

- What is the relationship between the volume and the pressure of the gas?
- 3 litres of oxygen gas at one atmosphere pressure were compressed to two atmospheres at constant temperature. Calculate the volume occupied by the oxygen gas (2mks)

26. Ammonia gas was passed into water as shown below

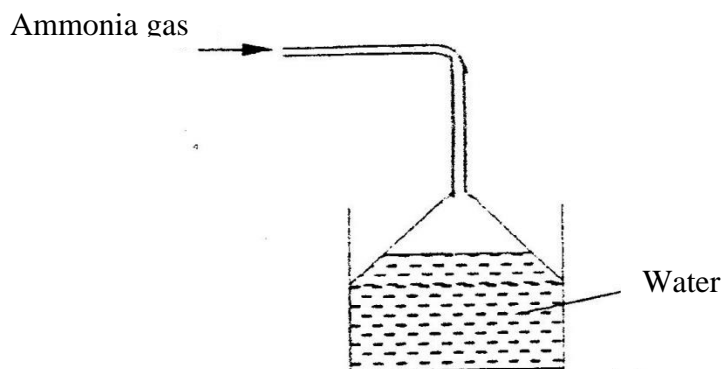

- What is the relationship between the volume and the pressure of the gas? (1mk)
- 3 litres of oxygen gas at one atmosphere pressure were compressed to two atmospheres at constant temperature. Calculate the volume occupied by the oxygen gas. (2mks)

27. During purification of copper by electrolysis, 1.48g of copper were deposited when current was passed through aqueous copper(II) sulphate for $2\frac{1}{2}$ hours. Calculate (CU = 63.5, 1 Faraday = 96,500C).

CHEMISTRY PAPER 233/1 K.C.S.E 2004 QUESTIONS

1. When a candle was burnt completely. The total mass product was found to be greater than the original mass of the candle. Explain

2. Ammonium nitrate was heated as shown in the set-up below (2 mks)

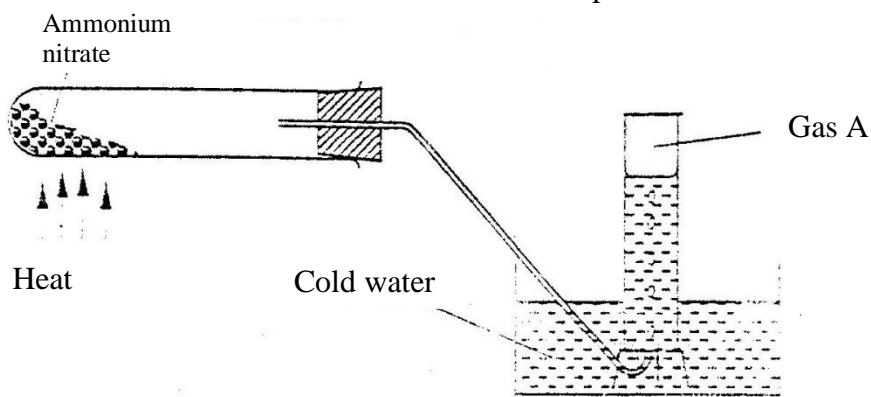

- a) Identify gas a.
b) State explain precaution that must be taken before heating id dropped.
3. The table below the first ionization energies of elements B and C.

Element	Ionisation energy KJ mol ⁻¹
B	494
C	736

What do these values suggest about the reactivity of B compared to that of C?
Explain

(2mks)

4. Dilute hydrochloric acid and solid sodium sulphite were reacted as shown in the set-up below

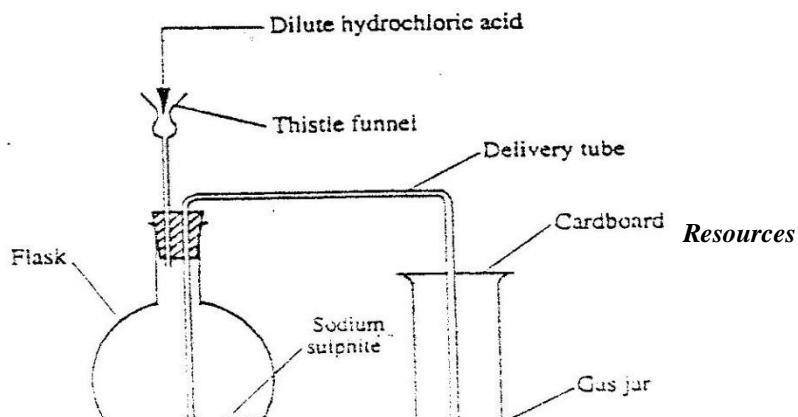

- a) Name the gas produced in the flask (2mks)
 b) Give two reasons why no gas was collected in the gas jar. (2mks)

5. Copper(II) sulphate reacts with barium chloride according to the equation below.

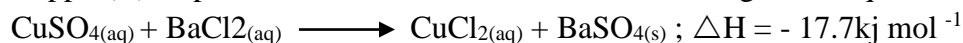

Calculate the temperature change when 900cm³ of m copper (II) sulphate were added to 600cm³ of 1M Barium (II) chloride.

6. Both diamond and graphite have giant atomic structures. Explain why diamond is hard while graphite is soft. (3mks)
7. Nitrogen forms many compounds in which its oxidation state varies.
 a) What is meant by oxidation state? (1mk)
 b) What is the oxidation state of nitrogen in Mg₃N₂ (1mk)
8. When wood is burnt, a grey powder called ash remains. The ash is stirred with water and filtered, a colourless solution is obtained.
 a) What is the main component of the colourless solution? (1mk)
 b) Explain your answer in (a) above (2mks)
9. Study the information in the table below and answer the questions that follows.

Alcohol	Heat of combustion on KJ mol ⁻¹
Methanol	715
Ethanol	1371
Propanol	2010
Butanol	2673

Give a reason why the difference in the molar heats of combustion between successive alcohols are close. (3mks)

10. Explain why a high temperature is required for nitrogen to react with oxygen (1mk)

11. Study the flow chart below and answer the questions that follow.

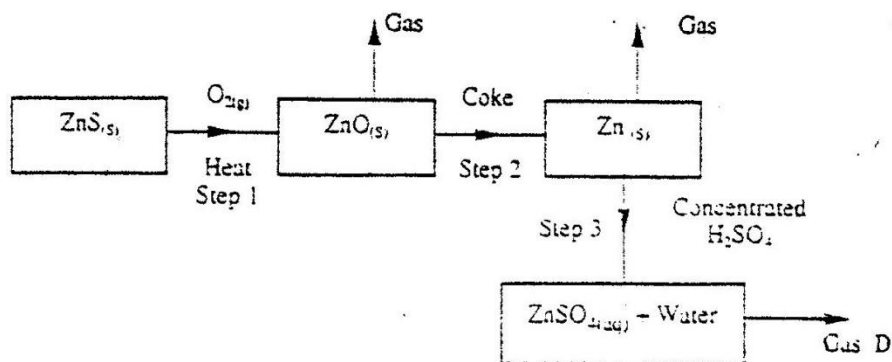

- a) State the condition necessary for the reaction in step 2 to occur (1mk)
- b) Name:
- i) Gas D (1mk)
- ii) One use of zinc (1mk)

12. Starting with aluminium sulphate, describe how a solid sample of aluminium hydroxide could be prepared. (3mks)

13. a) What is the name given to the smallest repeating unit of a polymer. (1mk)
- b) Draw the structure of the smallest repeating unit of a polyvinyl chloride (1mk)

14. When $X \text{ cm}^3$ of a solution of 0.5m magnesium carbonate was 8.4g.
- a) Write the ionic equation for the reaction that took place (1mk)
- b) Calculate the value of X. (C = 12.0, Mg 24.0; 016.0 (2mks)

15. In an experiment, a student put equal volumes of mixtures of ethanoic acid in water and ethanoic acid in hexane in two test – tubes as shown below. In each test tube, equal amounts of solid sodium hydrogen carbonate were added.

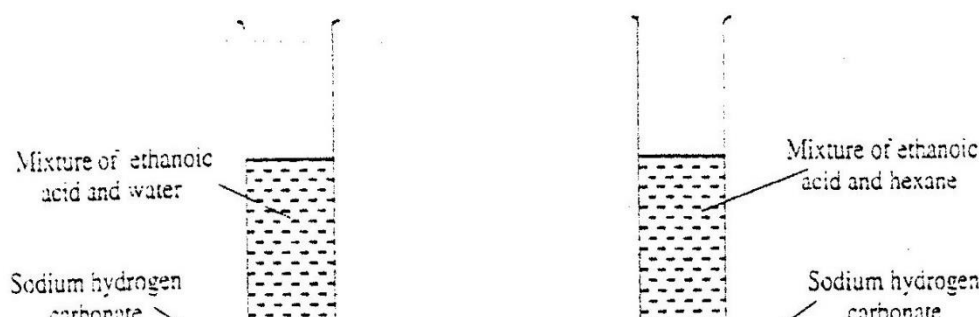

Mixture of ethanoic acid and water

Mixture of ethanoic acid and hexane

Sodium hydrogen carbonate

Sodium hydrogen Carbonate

Test – tube 1

Test – tube 1

- a) State the observation which was made in each test – tube (1mk)
- Test tube 1
- Test tube 2
- b) Explain the observation in (a) above (2mks)

16. Four metal F,G,H and J were each separately added to cold water, and steam. The table below is a summary of the observations made and the formulae of the hydroxides formed.

Metal	Cold water	Hot water	Steam	Formula of Hydroxide
F	Reacts slowly	Reacts fast	Reacts very fast	F(OH) ₂
G	No reaction	No reaction	No reaction	-
H	Fast	Reacts very fast	Reacts explosively	HOH
J	No reaction	Reacts slowly	Reacts fast	J(OH) ₂

- a) Which two elements are likely to be in the same group of the periodic table?
- b) Arrange the metals in the order of their reactivity starting with the most reactive (2mks)
17. Name the organic compound formed when $\text{CH}_3\text{CH}_2\text{CH}_2\text{CH}_2\text{CH}_2\text{OH}$ is reacted with concentrate sulphuric acid at 170°C (1mk)
18. Carbon monoxide gas passed over heated Iron (III) as shown in the diagram below.

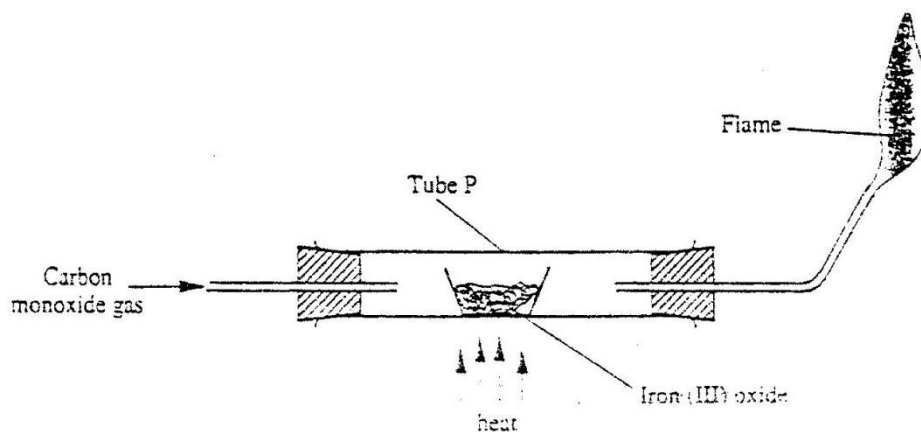

Iron (III) oxide

Heat

- a) Give the observation made in tube P. (1mk)
b) Write the equation for the reaction which takes place in tube P. (1mk)

19. A strip of metal Q was dipped into a solution of copper (II) sulphate and allowed to stand overnight. Give that:

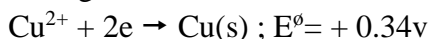

- a) State the observations which were made (2mks)
b) Give a reason for your answer in 19 (a) above. (1mk)

20. State two factors which determine the stability of an isotope. (2mks)

21. The reaction between a piece of magnesium ribbon with excess 2M hydrochloric acid was investigated at 25°C by measuring the volume of hydrogen gas produced as the reaction progressed. The sketch below represents the graph that was obtained.

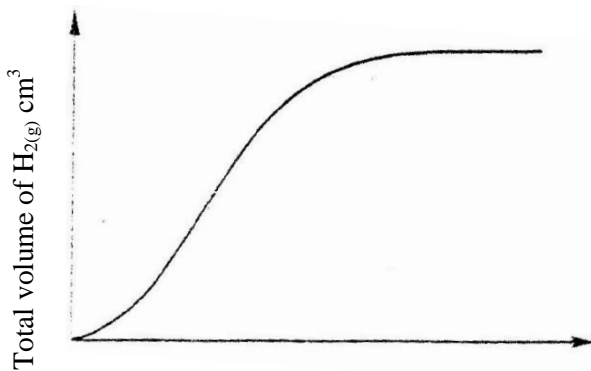

- a) Name one piece of apparatus that may be used to measure the volume of hydrogen gas produced.
b) On the same diagram, sketch the curve that would be obtained if the experiment when excess chlorine gas was bubbled into hot concentrated sodium hydroxide, the following reaction occurred.

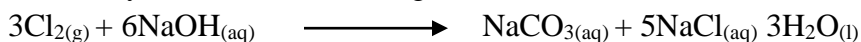

In which product did chlorine undergo oxidation? Explain

(3mks)

23. 1cm^3 of soap was added to two test – tubes each containing water obtained from different sources. The lather produced in each test tube is represented as shown in the diagram below.

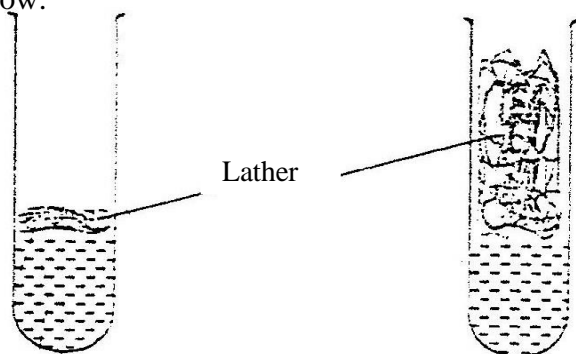

Test – tube 1

Test – tube 2

Explain why there is more lather in test – tube 2 than in test – tube 1.

(3mks)

24. Carbon dioxide can be dissolved in water under pressure to make an acidic solution.

a) What is meant by an acidic solution?

(1mk)

b) aqueous lead (II) nitrate reacts with the acidic solution to form a precipitate.

Write an ionic equation for the reaction.

(1mk)

25. Below is a sketch of a reaction profile.

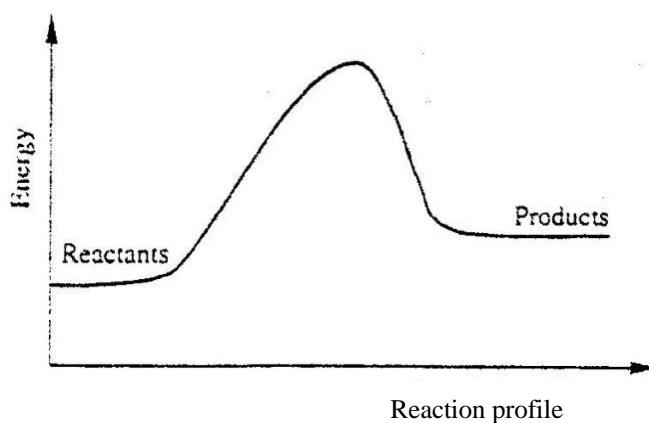

a) On the diagram, show the heat of reaction, ΔH .

(1mk)

b) State and explain the type of reaction represented by the profile

(2mks)

26. The diagram below represents the set – up that was used to study the effect of an electric current on pure water and dilute sulphuric acid.

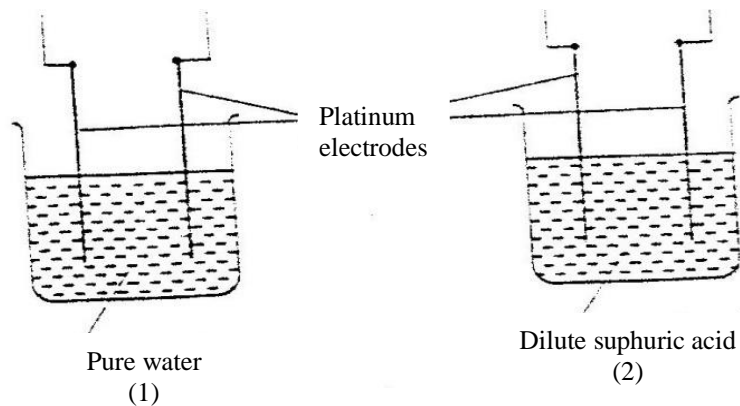

State and explain the observation made when each experiment was started. (3mks)

27. A piece of chromatography paper was spotted with coloured inks obtained from pens labeled 1 to 6. The diagram below shows the spots after the chromatogram was developed.

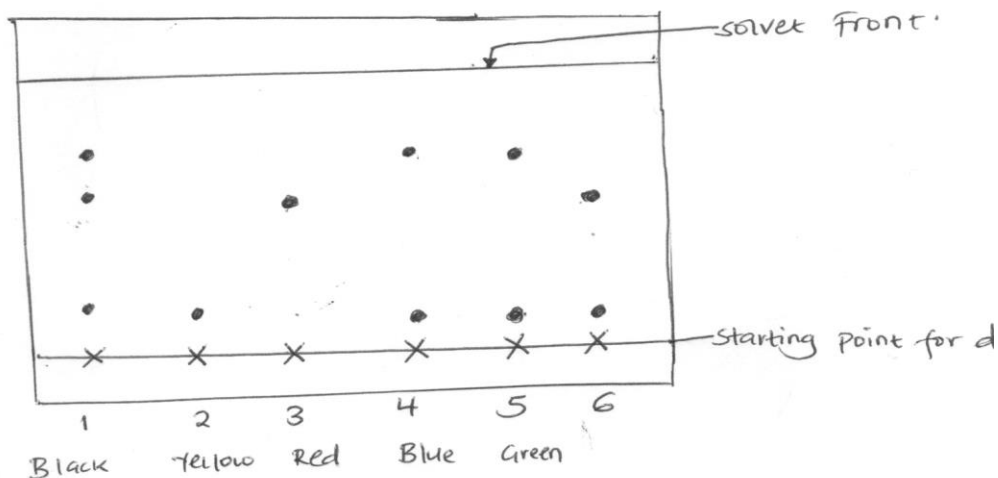

- a) Which two pens contained in the same pigment? (1mk)
- b) Which pens contained only one pigment (1mk)
- c) According to the chromatogram, which pigments are present in the ink of pen number 6. (1mk)

CHEMISTRY PAPER 233/1

K.C.S.E 2005 QUESTIONS

1. State one use of sodium hydrogen carbonate. (1 mk)
2. Calcium oxide can be used to dry ammonia gas. (2 mk)
 - a) Explain why calcium oxide is not used to dry hydrogen chloride gas (2 mk)
 - b) Name one drying agent for hydrogen chloride gas
3. The set-up below was used to demonstrate the effect of heat on hard water

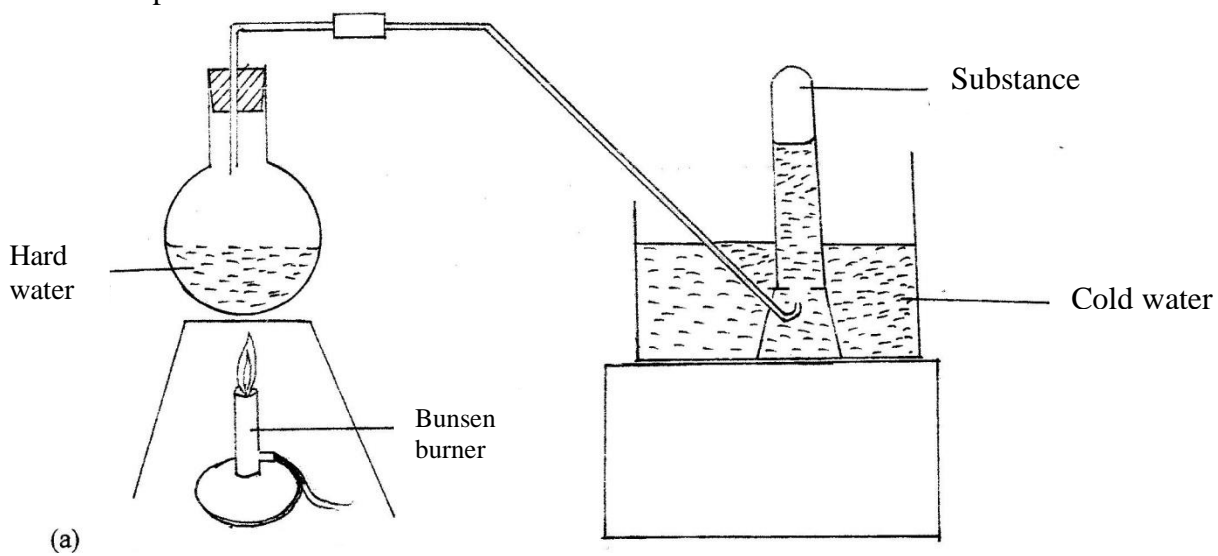

- a) Name substance A. (1 mk)
 b) Explain why the heating of hard water produced substance A. (2mks)

4. Using dots (.) and crosses(x) to represent electrons, show bonding in the compounds formed when the following elements react:

(si = 14, Na = 11 and Cl = 17) (1 mk)

- a) Sodium and chlorine (1 mk)
 b) Silicon and chlorine (1 mk)

5. Zinc oxide reacts with acids and alkalis

- a) Write the equation for the reaction between zinc oxide and:
 i) Dilute sulphuric acid (1mk)
 ii) Sodium hydroxide solution (1 mk)

- b) What property of zinc oxide is shown by the reaction in (a) above? (1 mk)

6. Use the information in the table below to answer the questions that follow. (The letters do not represent the actual symbols of the elements)

Element	B	C	D	E	F
Atomic number	18	5	3	5	20
Mass number	40	10	7	11	40

- a) Which two letters represent the same element? Give a reason. (2mks)
 b) Give the number of neutrons in an atom of element D (1 mk)

7. Give the name and draw the structural formula of the compound formed when one mole of ethane reacts with one mole of chlorine gas.

8. Determine the oxidation state of sulphure in the following compounds: (2 mks)

- a) H₂S.....
 b) Na₂S.....

9. A certain carbonate, GCO₃, reacts with dilute hydrochloric acid according to the equation given below:



If 1 g of the carbonate reacts completely with 20 cm³ of 1 M hydrochloric acid , calculate the relative atomic mass of G

(C = 12.0 = 16.0)

- 10 The sketch completely with substance H is converted into J. study it and answer the question that follows.

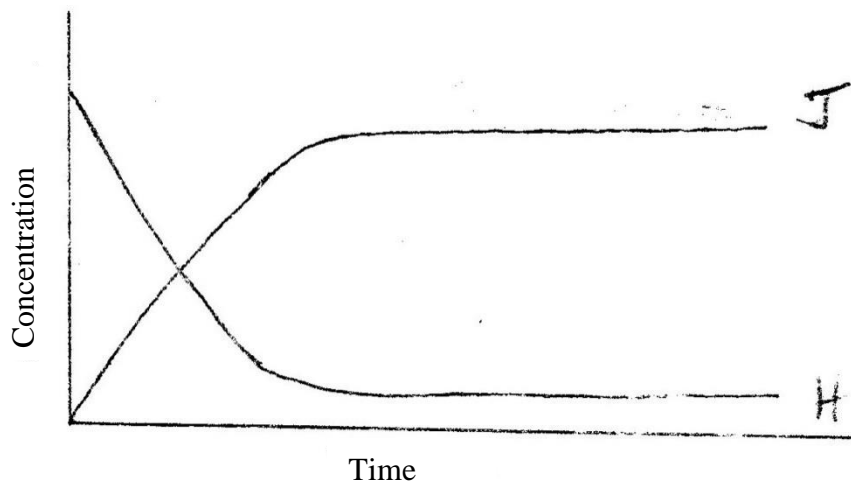

Why do the two curves become horizontal after sometime?

11. The reaction between how concentrated sodium hydroxide and chlorine produces sodium chlorate (V), sodium chloride and water

- (a) Write the equation for the reaction
(b) Give one use of sodium chlorate (V)

12. In the industrial extraction of lead, the ore is first roasted in a furnace. The solid mixture obtained is then fed into another furnace together with coke, limestone and scrap iron.

State the function of each of the following in this process:

(3 mks)

- (a) Coke
(b) Limestone
(c) Scrap iron

13. Methane reacts with oxygen according to the equation given below.

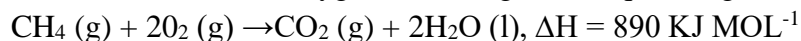

Calculate the volume of methane which would produce 111.25 kJ when completely burnt. (Molar volume of a gas = 24 litres.)

(2 mks)

14. 100 g of a radioactive substance was reduced to 12.5 g in 15.6 years. Calculate

the half – life of the substance. (2 mks)

15. In terms of structure and bonding, explain why graphite is used as a lubricant. (2mks)

16. The table below gives some information about elements I,II,III and IV which are in the same group of the periodic table. Use the information to answer the questions that follows.

Element	First Ionisation energy (kJmol ⁻¹)	Atomic Radius (nm)
I	520	0.15
II	500	0.19
III	420	0.23
IV	400	0.25

State and explain the relationship between the variations in the first ionization energies and the atomic radii. (3 mks)

17. (a) what condition is necessary for an equilibrium to be established? (1 mk)

(b) When calcium carbonate is heated, the equilibrium shown below is established

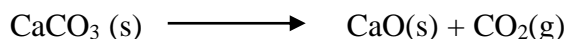

How would the position of equilibrium be affected if a small amount of dilute potassium hydroxide is added to the equilibrium mixture? Explain (2 mks)

18. In an experiment to investigate the conductivity of substances, a student used the set – up shown below.

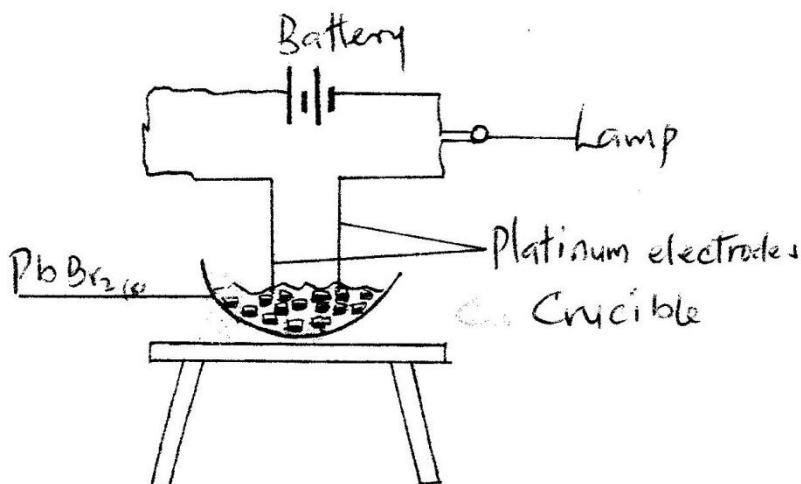

The Student noted that the bulb did not light (1mk)

- (a) What had been omitted in the set- up? (2 mks)
 (b) Explain why the bulb lights when the omission is corrected

19. The scheme below shows the energy changes that are involved between ice, water and steam. Study it and answer the questions that follow

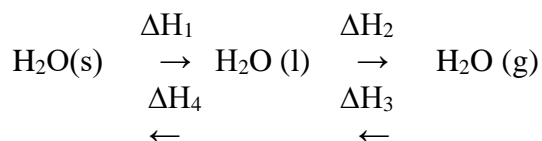

- (a) What name is given to the energy change, ΔH_4 ? (1mk)
 (b) What is the sign of ΔH_3 ? Give a reason (2 mks)

20. Equal volumes of 1M monobasic acids L and M were each reacted with excess magnesium turnings. The table below shows the volumes of the gas produced after one minute.

Acid	Volume of gas (cm ³)
L	40
M	100

Explain the differences in the volumes of the gas produced (2 mks)

21. The diagram below shows a set- up that was used to prepare and collect a sample of nitric acid

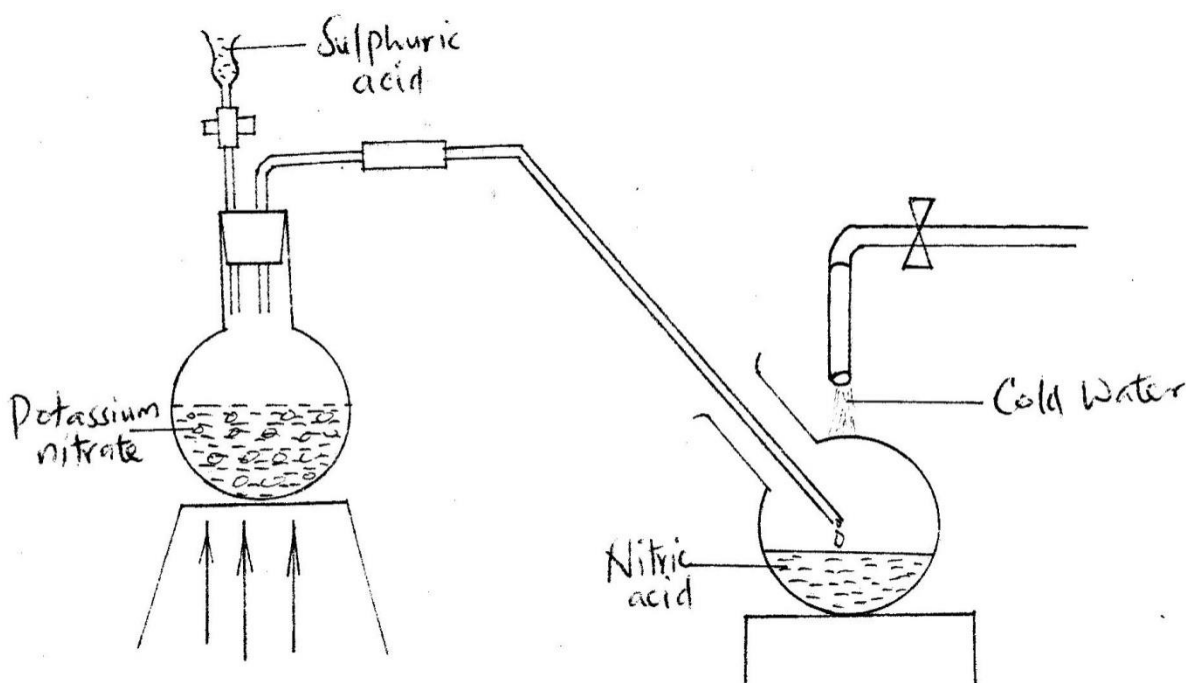

- Give a reason why it is possible to separate nitric acid from sulphuric acid in the set – up (1 mk)
- Name another substance that can be used instead of potassium nitrate (1 mk)
- Give one use of nitric acid (1 mk)

22. Study the flow chart below and answer the questions that follow

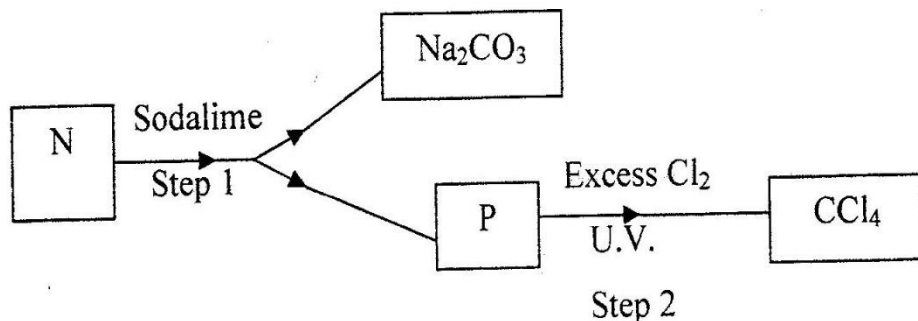

(a) Identify N and P (2 mks)

N.....
P

(b) What name is given to the type of halogenations/ chlorination reaction in step 2?

23. The set – up below was used to obtain a sample of iron

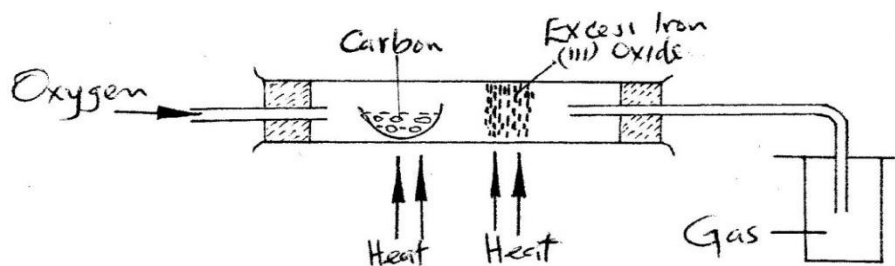

Write two equations for the reactions which occur in the combustion tube (2mks)

24. In an experiment, a gas jar containing most sulphur dioxide was inverted over another gas jar containing hydrogen sulphide gas

- State and explain the observation that was made (2mks)
- State the precaution that should be taken when carrying out this experiment (1mk)

25. When a few drops of aqueous ammonia were added to copper (II) nitrate solution, a light blue precipitate was formed. On addition of more aqueous ammonia, a deep blue solution was formed.

Identify the substance responsible for the:

- a. Light blue precipitate (1mk)
- b. Deep blue solution (1mk)

26. When a current of 0.82A was passed for 5 hours through an aqueous solution of metal Z, 2.65 g of the metal were deposited. Determine the charge on the ions of metal Z. (1 Faraday = 96500 Coulombs:
Relative atomic mass of Z = 52

27. Dry carbon monoxide gas reacts with heated lead (II) oxide as shown in the equation below

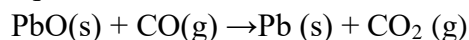

- (a) Name the process undergone by the lead (II) oxide (1 mk)
- (b) Give a reason for your answer in (a) above (1mk)
- (c) Name another gas that can be used to perform the same function as carbon monoxide gas in the above reaction.

28. When a hydrocarbon was completely burnt in oxygen, 4.2g of carbon dioxide and 1.71 g of water were formed. Determine the empirical formula of the hydrocarbon

(H= 1.0 ; C=12.0 ; O = 16.0) (3 mks)

CHEMISTRY PAPER 1 KCSE 2006 QUESTIONS

- 1. (a) What is meant by isomerism? (1mk)
- (b) Draw and name two isomers of butane. (2 mks)

2. The diagram below represent a set-up that was used to show that part of air is used during burning.

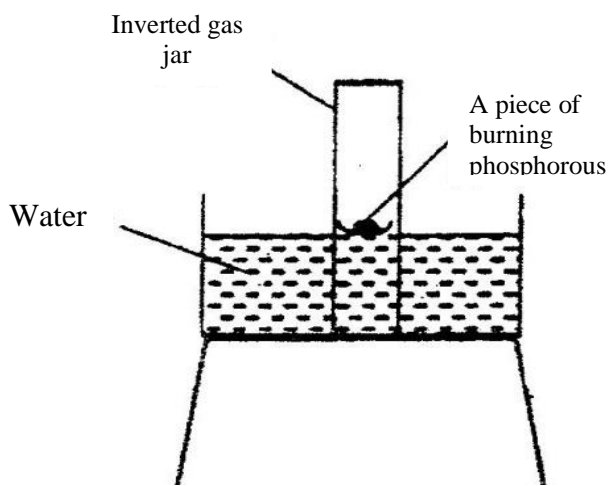

Resources

- a) Given that phosphorus used was in excess, draw a diagram of the set-up at the end of the experiment (when there was no further observable change). (1mk)
- b) Suggest one modification that should be made on the apparatus if the percentage of the air used is to be determined. (1mk)
3. 60cm^3 of oxygen gas diffused through a porous partition in 50 seconds. How long would it take 60cm^3 of sulphur (IV) oxide gas to diffuse through the same partition under the same conditions? (S= 32.0, O = 16.0) (3mks)
4. a) Complete the nuclear equation below. (1mk)
- $$\begin{array}{ccc} 37 & & 37 \\ \text{A} \dots\dots\dots & \text{B} & \\ 18 & & 17 \end{array}$$
- (b) State one:
- (i) Use of radioisotopes in agriculture (1mk)
- (ii) Danger associated with exposure of human beings to radioisotopes (1 mk)
5. The atomic numbers of elements C and D are 19 and 9 respectively. State and explain the electrical conductivity of the compound CD in:
- (a) Solid state (1 ½ mks)
- (b) aqueous state. (1 ½ mks)
6. In an experiment to study the properties of concentrated sulphuric acid, a mixture of the acid and wood charcoal was heated in a boiling tube.
- (a) write the equation of the reaction that took place in the boiling tube. (1mk)
- (b) Using oxidation numbers, show that reduction and oxidation reactions took place in the boiling tube (2 mk)

Solid
sodium
chloride

Hydrogen
chloride gas

Concentrated
sulphuric acid

- a) State the purpose of concentrated sulphuric acid in the wash bottle. (1 mk)
- b) Write an equation for the reaction between dry hydrogen chloride gas and heated iron (1 mk)
- c) Hydrogen chloride gas is dissolved in water to make hydrochloric acid. State one use of hydrochloric acid.

14. Below is a list of oxides.
MgO, N₂O, K₂O, CaO, and Al₂O₃.
Select:

- a) A neutral oxide (1 mk)
- b) A highly water soluble basic oxide (1 mk)
- c) An oxide which can react with both sodium hydroxide solution and dilute hydrochloric acid. (1 mk)

15. Study the standard reduction potential given and answer the questions that follow.
(The letters are not the actual symbols of the elements).

		E ⁰ (volts)
M ²⁺ _(aq) + 2e	→	M _(s) -0.76
N ²⁺ _(aq) + 2e	→	N _(s) -2.37
P ⁺ _(aq) + e	→	P _(s) +0.80
Q ²⁺ _(aq) + 2e	→	Q _(s) -0.14

- a) The standard reduction potential for Fe²⁺_(aq) is -0.44 volts. Select the element

which would best protect iron from rusting. (1 mk)

b) Calculate the E° value for the cell represented as $M_{(s)} / M^{2+}_{(aq)} // P^{+}_{(aq)} / P_{(s)}$. (2mks)

16 When hydrogen sulphide gas was bubbled into an aqueous solution of iron (III) chloride, a yellow precipitate was deposited. (1mk)

a) The standard reduction potential for $Fe^{2+}_{(aq)}$ is -0.44 volts. Select the element which would best protect iron from rusting. (1 mk)

b) Write an equation for the reaction that took place. (1 mk)

c) What type of reaction was undergone by hydrogen by hydrogen sulphide in this reaction? (1mk)

17. The first step in the industrial manufacture of nitric acid is the catalytic oxidation of ammonia gas.

(a) What is the name of the catalyst used? (1 mk)

(b) Write the equation for the catalytic oxidation of ammonia gas. (1mk)

(c) Nitric acid is used to make ammonium nitrate, state two uses of ammonium nitrate. (1 mk)

18. Study the diagram below and answer the question that follows.

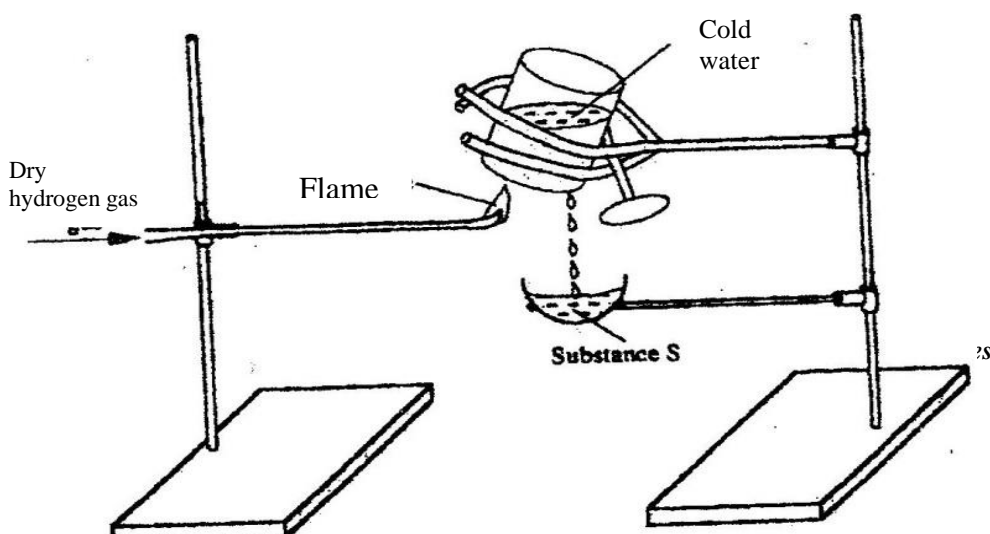

Substance S

Describe one chemical test that can be carried out to identify substance s. (2 mks)

19. a) starting from solid magnesium hydroxide. (1mk)
b) Give one use of magnesium hydroxide. (1 mk)
20. a) Distinguish between a covalent bond and a co-ordinate bond (2 mks)
b) Draw a diagram to show bonding in an ammonium ion. (1mk)
21. (a) Explain why the metals magnesium and aluminium are good conductors of electricity. (1 mk)
b) Other than cost, give two reasons why aluminium is used for making electric cables while magnesium is not (2mks)

22. The diagram below represents part of a set – up used to prepare and collect gas T.

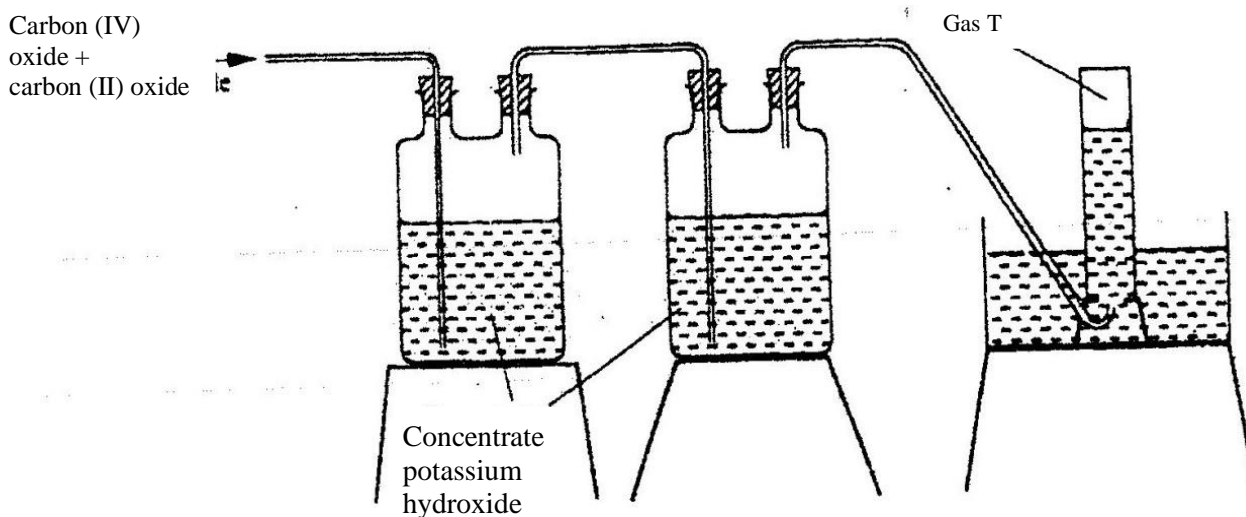

- a) Name two reagents that are reacted to produce both carbon (IV) oxide and carbon(II) oxide. (1mk)
- b) Write the equation for the reaction which takes place in the wash bottles. (1mk)
- c) Give a reason why carbon(II) oxide is not easily detected. (1mk)

23. Explain why the boiling point of ethanol is higher than that of hexane.
(Relative molecular mass of ethanol is 46 while that of hexane is 86)

24. a) Complete the table below to show the colour of the given indicator in

Indicator	Colour in	
	Acid solution	Basic solution
Methyl orange	Yellow
Phenolphthalein	Colourless

b) How does the P^H value of 0.1 M potassium hydroxide solution compare with that of 0.1M aqueous ammonia? Explain. (2mks)

25. Study the properties of substances V1 to V4 in the table below and answer the questions that follow.

Substance	Solubility in water	Solubility	Melting Point($^{\circ}C$)	Boiling point($^{\circ}C$)
V1	Insoluble	Soluble	-30	250
V2	Insoluble	Insoluble	1535	3000
V3	Insoluble	Soluble	16.8	44.8
V4	Insoluble	Soluble	75	320

a) Which of the substances are liquids at 240C?

b) Describe how a mixture containing V2 and V4 can be separated (2mks)

26. The graph below shows a curve obtained when water at 20°C was heated for 15 minutes.

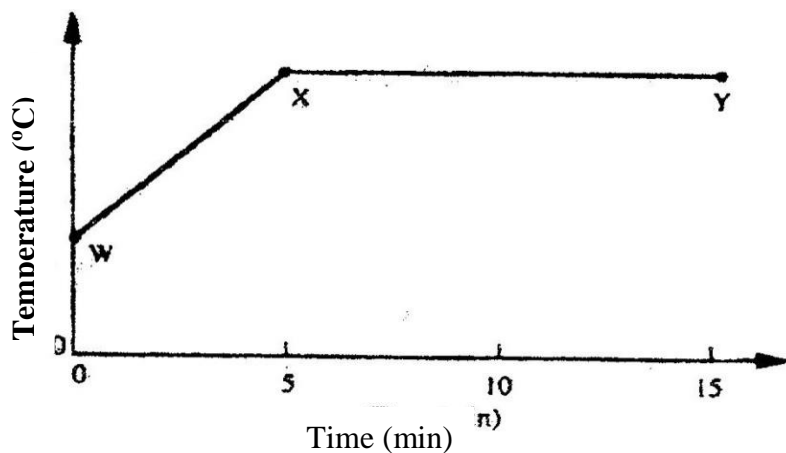

- a) What happens to the water molecules between points W and x? (1mk)
- b) In which part of the curve does a change of state occur? (1mk)
- c) Explain why the temperature does not rise between points X and Y. (1mk)
27. Study the flow chart below and answer the questions that follow.

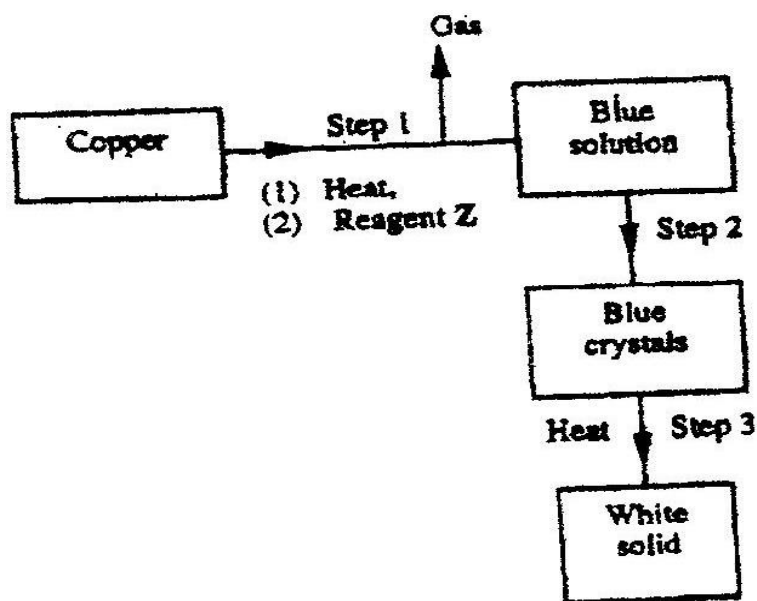

- a) Name reagent z. (1mk)
- b) Describe the process which takes place in step 2. (1mk)
- c) Identify the white solid. (1mk)

28. Study the diagram below and answer the questions that follow.

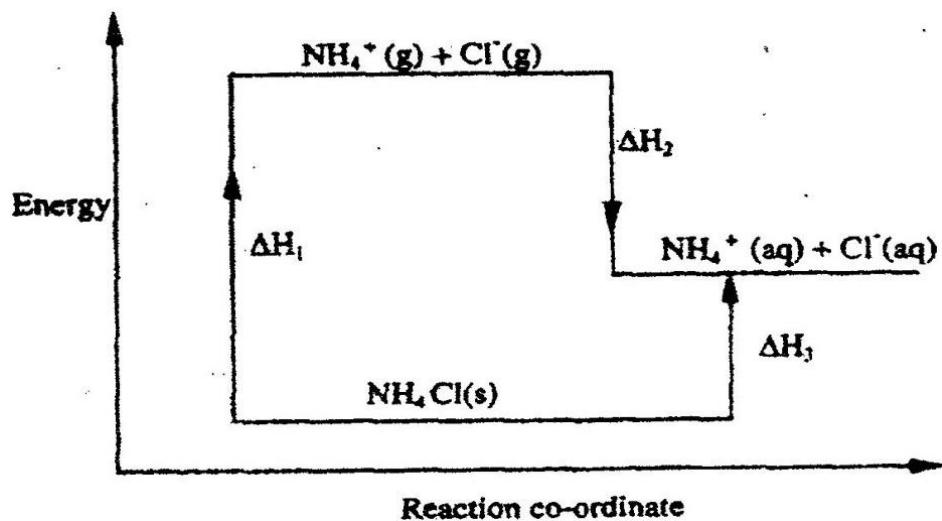

- a) What do ΔH_1 and ΔH_2 represent? (2mks)
- b) Write an expression to show the relationship between $\Delta H_1, \Delta H_2$ and ΔH_3 . (1mk)

CHEMISTRY PAPER 233/1
KCSE 2007 QUESTIONS

1. The diagram below shows a “Jiko” when in use. Study it and answer the questions that follow.

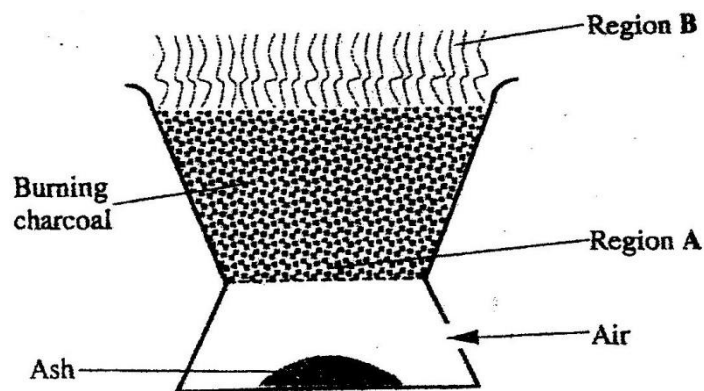

- a) Identify the gas formed at region A. (1mk)
- b) State and explain the observation made at region B. (2mks)
2. 15.0cm^3 of ethanoic acid (CH_3COOH) was dissolved in water to make 500cm^3 of solution. Calculate the concentration of the solution in moles per litre. (C=12.0;H=1.0;O=16.0; density of ethanoic acid is 1.05 g/cm^3) (3mks)
3. Both chlorine and iodine are halogens.
- a) What are halogens? (1mk)
- b) In terms of structure and bonding, explain why the boiling point of chlorine is lower than that of iodine. (2mks)
4. The diagram below shows a Bunsen burner when in use.

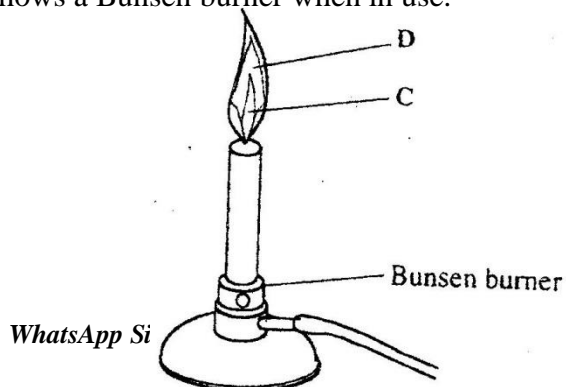

- Name the regions labeled C and D. (2mks)
5. When a student was stung by a nettle plant, a teacher applied an aqueous solution of ammonia to the affected area of the skin and the student was relieved of pain. Explain. (2mks)
6. In an experiment, a few drops of concentrated nitric acid were added to aqueous iron(II) sulphate in a test – tube. Excess sodium hydroxide solution was then added to the mixture.
- a) State the observations that were made when:
- i) Concentrated nitric acid was added to aqueous iron (II) sulphate (1mk)
- ii) Excess sodium hydroxide was added to the mixture. (1mk)
- b) Write and ionic equation for the reaction which occurred in (a) (ii) above. (1mk)
7. a) Use the information given below to draw a labeled diagram of an electrochemical cell that can be constructed to measure the electromotive force between G and J.
- $G^{2+}(aq) + 2e \rightleftharpoons G(s) ; E^{\theta} = - 0.74 V$
- $J^{2+}(aq) + 2e \rightleftharpoons J(s) ; E^{\theta} = -0.14 V$
- b) Calculate the E^{θ} value for the cell constructed in (a) above. (1mk)
8. Explain why there is general increase in the first ionization energies of the elements in period 3 of the periodic table from left to right. (2mks)

9. Study the flow chart below and answer the question that follows.

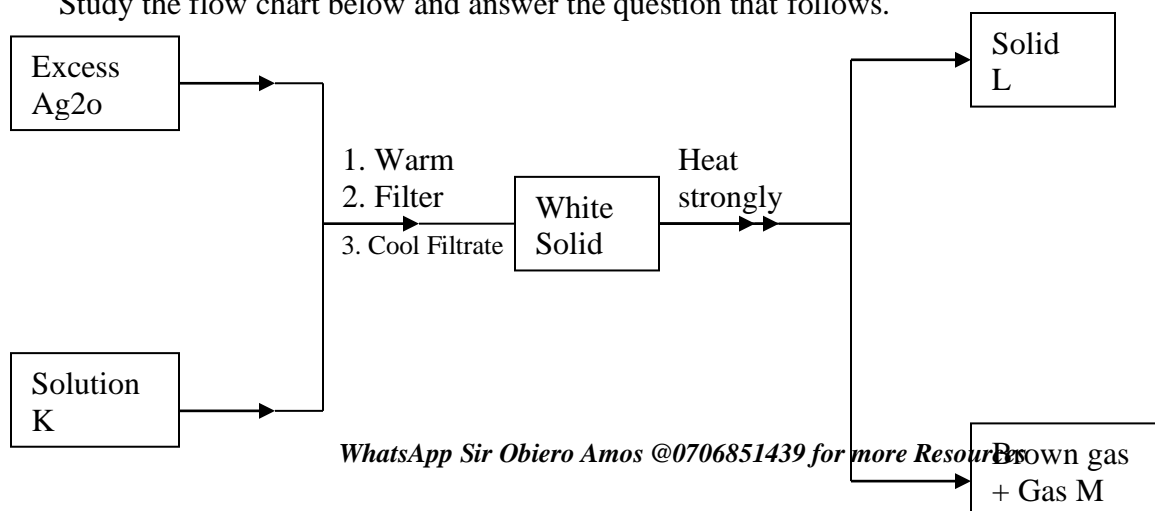

Identify:

(3mks)

- a) Solution K
- b) Solid L
- c) Gas M

9. The thermo chemical equations for the formation of hydrogen peroxide under standard conditions are:

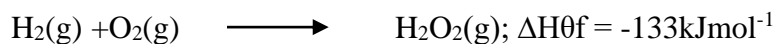

Write the thermo chemical equation for the molar heat of vaporization of hydrogen peroxide.

(2mks)

10. The set-up below was used to collect a dry sample of a gas.

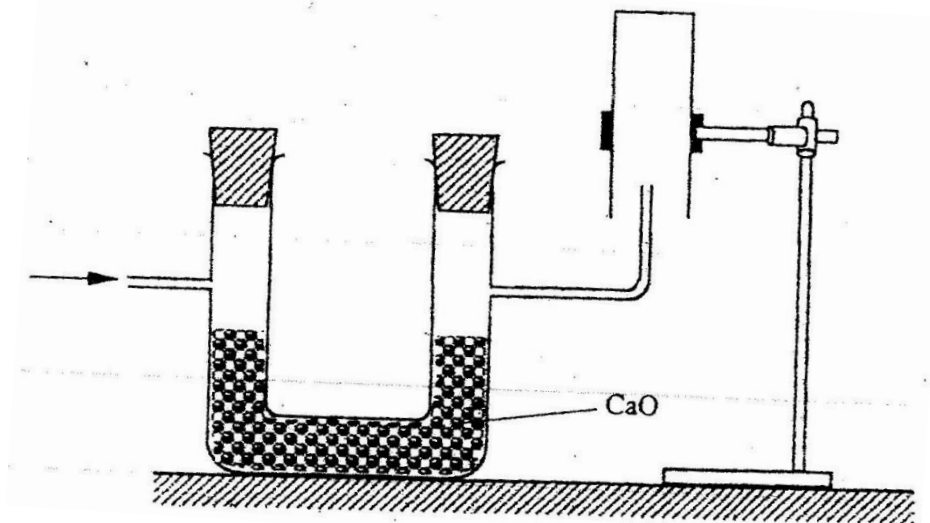

Give two reasons why the set-up cannot be used to collect carbon (IV) oxide gas. **(2mks)**

12. a) State the Charles law **(1mk)**
- b) The volume of a sample of nitrogen gas at a temperature of 291 K and

1.0×10^5 Pascal's was $3.5 \times 10^{-2} \text{m}^3$. Calculate the temperature at which the volume of the gas would be $2.8 \times 10^{-2} \text{m}^3$ at 1.0×10^5 Pascal. (2mks)

13. a) name the process that takes place when:
- (i) Crystals of zinc nitrate change into solution when exposed to air (1mk)
 - (ii) An alcohol reacts with an organic acid in the presence of a catalyst to form a sweet smelling compound. (1mk)

b) Propane can be changed into methane and ethane as shown in the equation below;

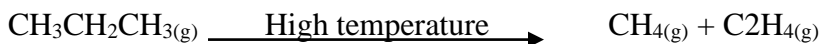

Name the process undergone by propane. (1mk)

14. a) Distinguish between nuclear fission and nuclear fusion. (2mks)

b) Describe how solid wastes containing radioactive substances should be disposed of. (1mk)

15. a) Explain why permanent hardness in water cannot be removed by boiling. (2mks)

b) Name two methods that can be used to remove permanent hardness from water. (1mk)

16 The table below shows the tests that were carried out on solid N and the observations made.

I	Test	Observations
II	Dilute hydrochloric acid was added to solid N.	A colourless solution was formed.
III	To the colourless solution obtained in test II, excess sodium hydroxide solution was added.	A white precipitate was formed which dissolved to form a colourless solution.

Write the formula of the anion in;

- a) Solid N (1mk)
- b) The colourless solution formed in test III (1mk)

17. The relative formula mass of a hydrocarbon is 58. Draw and name two possible structures of the hydrocarbon (C=12.0; H=1.0) (3mks)

18. starting with sodium metal, describe how a sample of crystals of sodium hydrogen

carbonate may be prepared.

(3mks)

19 The flow chart below shows steps used in the extraction of zinc from one of its ores.

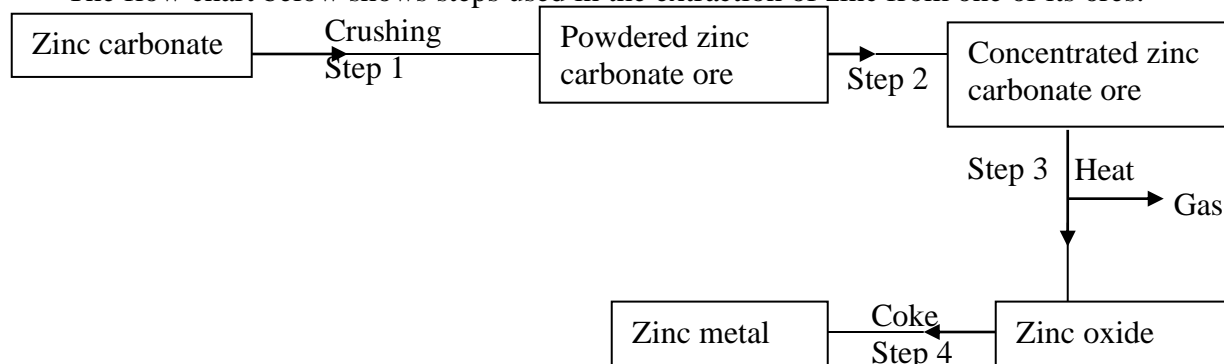

- a) Name the process that is used in step 2 to concentrate the ore. (1mk)
- b) Write an equation for the reaction which takes place in step 3. (1 mk)
- c) Name one use of zinc other than galvanizing. (1mk)
20. An alcohol has the following composition by mass: hydrogen 13.5%, oxygen 21.6% and carbon 64.9%
- a) Determine the empirical formula of the alcohol($C=12.0$; $H=1.0$)= 16.0). (2mks)
21. a) When brine is electrolyzed using inert electrodes, chlorine gas is liberated at the anode instead of oxygen. Explain this observation. (2mks)
- b) Name the product formed at the cathode. (1 mk)
22. 6.84g of aluminium sulphate were dissolve in 150cm³ of water. Calculate the molar concentration of the sulphate ions in the solution. (Relative formula mass of aluminium sulphate is 342)
23. The table below shows the relative molecular masses and the boiling points of pentane and propan-1-01

	Relative molecular mass	Boiling point(°C)
Pentane	72	36
Propan-1-ol	60	97

Explain why the boiling point of propan-1-ol is higher than that of pentane. (2mks)

24. State and explain the observations made when excess ammonia gas reacts with chlorine gas (3mks)

25. The diagram below shows a student's set-up for the preparation and collection of hydrogen gas.

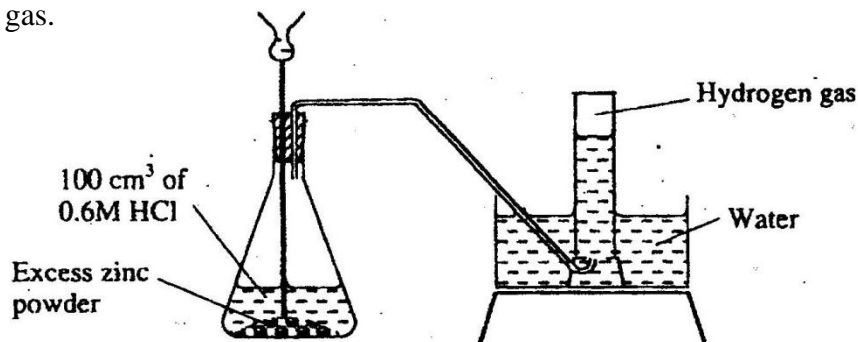

(a) How would the final volume of hydrogen gas produced be affected if 80cm³ of 0,75 M hydrochloric acid was used? (1mk)

(b) Give a reason why helium is increasingly being preferred to hydrogen in weather balloons.

26. The table below shows the number of valence electrons of the element P, Q and R.

Element	P	Q	R
Number of valence electrons	3	5	2

a) Explain why p and R would not be expected to form a compound. (1mk)

b) Write an equation to show the effect of heat on the carbonate of R (1mk)

c) Write the formula for the most stable ion of q. (1mk)

27. The diagram below formula for the most stable ion of Q. (1mk)

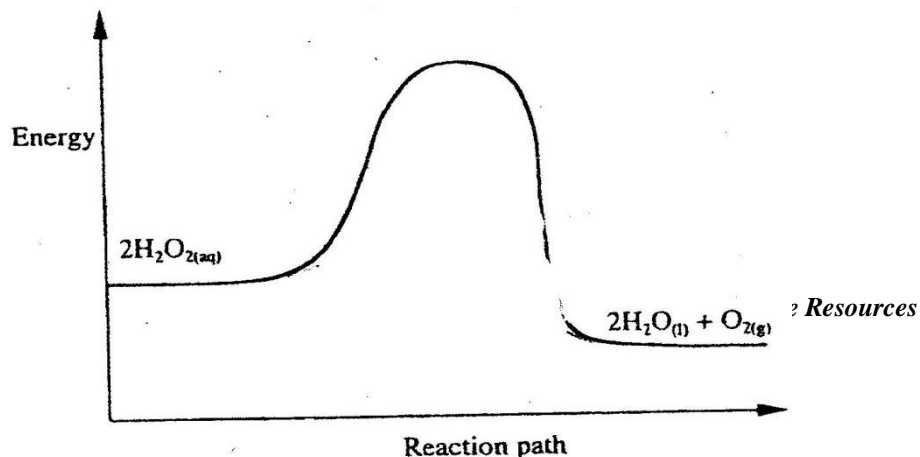

On the same axis, sketch the graph for the decomposition of hydrogen peroxide when manganese (IV) oxide is added. (2mks)

28. During the electrolysis of aqueous silver nitrate, a current of 5.0a was passed through the electrolysis for 3 hours.

- a) Write the equation for reaction which took place at the anode. (1mk)
- b) Calculate the mass of silver deposited ($A_g = 108$; $IF=96500C$) (2mks)

29. The diagram below is a section of a model of the structure of element T.

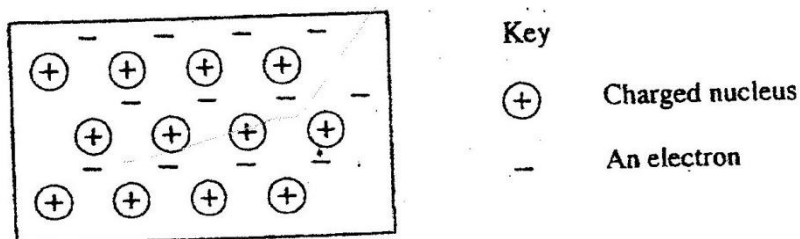

- a) State the type of bonding that exists in T. (1mk)
- b) In which group of the period table does element T belong? Give a reason. (2mks)

30. Below is a sketch of a graph showing the change in viscosity? (Ease of flow) with temperature when solid sulphur is heated.

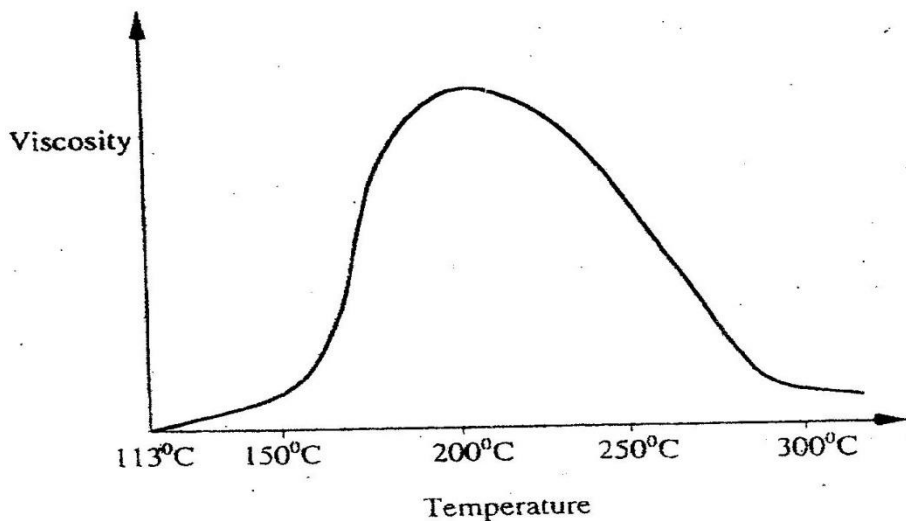

Describe what happens to the sulphur molecules when sulphur is heated from 150⁰C to about 200⁰C.

CHEMISTRY PAPER 233/1 KCSE 2008 QUESTIONS

1. A small crystal of potassium manganate (VII) was placed in a beaker water. The beaker was left standing for two days without shaking. State and explain the observations that were made. (2mks)

2. When a hydrated sample of calcium sulphate $\text{CaSO}_4 \cdot \text{XH}_2\text{O}$ was heated until all the water was lost, the following data recorded;

Mass of crucible = 30.296 g

Mass of crucible +hydrated salt = 33.111 g

Mass of crucible + anhydrous salt = 32.781 g

Determine the empirical formula of the hydrated salt (Relative formula mass of $\text{CaSO}_4=136$, $\text{H}_2\text{O}=18$). (3mks)

3. Complete the following table by filling in the missing test and observations (3mks)

No.	Gas	Test	Observation
I	Chlorine	Put a moist red litmus into the gas	
II	Sulphure (IV) oxide		Paper turns green
III	Butane	Add a drop of bromin water	

4. The structure of a detergent is

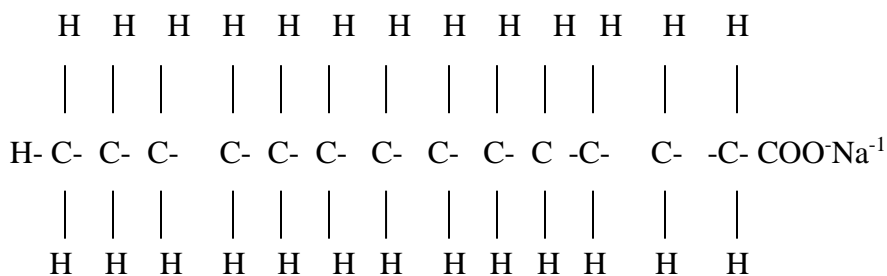

- a) Write the molecular formula of the detergent. (1mk)
- b) What type of detergent is represented by the formula? (1mk)
- c) When this type of detergent is used to wash linen in hard water, spots (mks) are left on the linen. Write the formula of the substance responsible for the spots (1mk)
5. Phosphoric acid is manufactured from calcium phosphate according to the following equation.
- $$\text{Ca}_3(\text{PO}_4)_2(\text{s}) + 3\text{H}_2\text{SO}_4(\text{l}) \longrightarrow 2\text{H}_3\text{PO}_4(\text{aq}) + 3\text{CaSO}_4(\text{s})$$
- Calculate the mass in (Kg) of phosphoric acid that would be obtained if 155 Kg of calcium phosphate reacted completely with the acid
(Ca=40, P=31, S=32, O=16, H=1) (2mks)
6. The structure below represents a sweet smelling compound
- $$\begin{array}{c}
 \text{O} \\
 || \\
 \text{CH}_3 - \text{CH}_2 - \text{CH}_2 - \text{C} - \text{O} - \text{CH}_2 - \text{CH}_2 - \text{CH}_3
 \end{array}$$
- Give the names of the two organic compounds that can be used to prepare this compound in the laboratory. (2mks)
7. a) What are isotopes? (1mk)
- b) Determine the number of neutrons in $^{18}_8\text{O}$. (1mk)
8. a) State the observation made at the end of the experiment when a mixture of iron powder and sulphur is heated in a test tube. (1mk)
- b) Write an equation for the reaction the product in (a) above and dilute

hydrochloric acid. (1mk)

c) When a mixture of iron powder and sulphur is heated, it glows more brightly than that of iron fillings and sulphur. Explain this observation (1mk)

9. Zinc reacts with both concentrated and dilute sulphuric (VI) acid. Write equations for two reactions. (2mk)

10. When magnesium was burnt in air, a solid mixture was formed. On addition of water to the mixture a gas which turned moist red litmus paper blue was evolved. Explain these observations.

11. The table below gives atomic numbers of elements represented by the letters A, B, C and D.

Element	A	B	C	D
Atomic number	15	16	17	20

Use the information to answer the questions that follow.

a) Name the type of bonding that exists in the compound formed when A and D react (1mk)

b) Select the letter which represents the best oxidizing agent. Give a reason for your answer. (2mks)

12. In an experiment, a test-tube full of chlorine water was inverted in chlorine water as shown in the diagram below and the set up left in sunlight for one day.

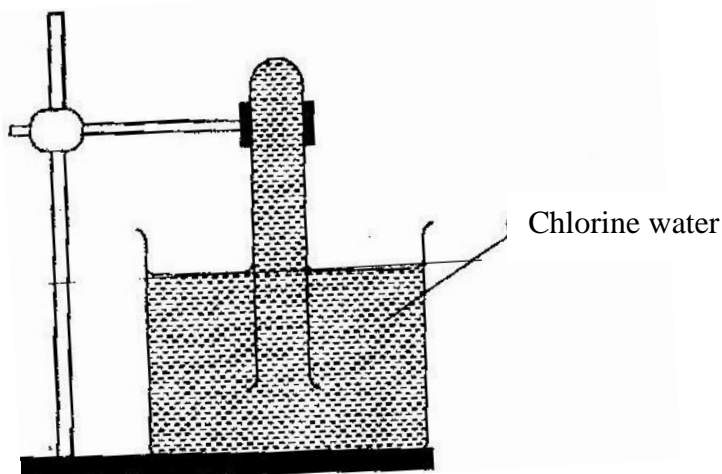

After one day, a gas was found to have collected in the test-tube

- Identify the gas.
- What will happen to the PH of the solution in the beaker after one day? Give an explanation. (2mks)

13. In a laboratory experiment hydrogen gas was passed over heated copper (II) oxide as shown the diagram below.

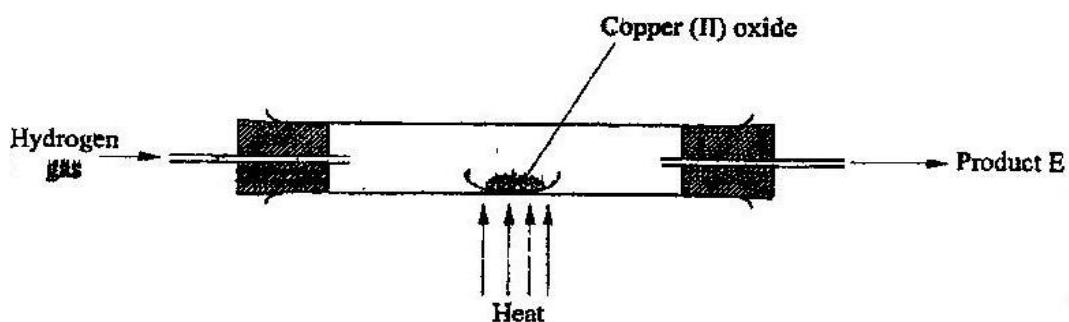

Describe a chemical test that can be used to identify the product e. (2mks)

14. Samples of urine from three participants F, G and H at an international sports meeting were spotted onto a chromatography paper alongside two from illegal drugs A₁ and A₂. A chromatogram was run using methanol. The figure below shows the chromatogram.

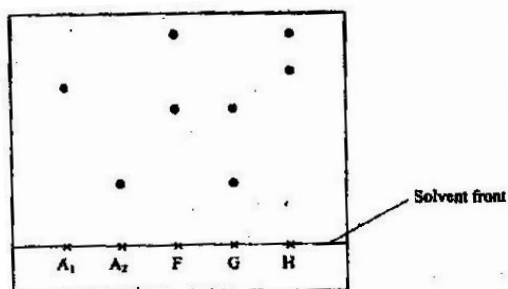

- a) Identify the athlete who had used an illegal drug. (1mk)
 b) Which drug is more soluble in methanol? (1mk)

15. The table below gives the solubilities of substances J, K and L at different temperatures

Substance	Solubility in grammes per 100 g water at			
	0°C	20°C	40°C	60°C
J	0.334	0.16	0.097	0.0058
K	27.60	34.0	40.0	45.5
L	35.70	36.0	40.0	37.3

Select the substance which, when dissolved in water, heat is given out. Give a reason (2mks)

16. Starting with copper metal, describe how a sample of crystals of copper (II) chloride may be prepared in the laboratory. (3mks)

17. A compound whose general formula is $M(OH)_3$ reacts as shown by the equation below.
 $M(OH)_{3(s)} + OH_{(aq)} \rightarrow M(OH)_{4(aq)}$

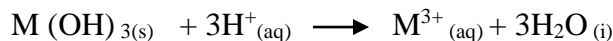

- (a) What name is given to compounds which behave like $M(OH)_3$ in the two Reactions (1 mk)
 (b) Name two elements whose hydroxides behave like that of M (2 mks)

18. The grid below is part of the periodic table. Use it to answer the questions that follow, (the letters are not the actual symbols of the elements).

				R	S	
N	Q				T	U
P						

- a) Indicate on the grid the position of an element represented by letter V whose atomic number is 14. (1mk)

b) Select a letter which reaction between Q and T. (1mk)

19. Select a letter which represents a mono atomic gas. (1mk)

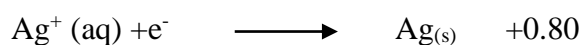
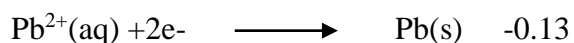
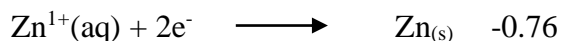

a) Write the cell representation for the electrochemical cell that would give the highest E (1mk)

b) State and explain the observations made when a copper rod is placed in a beaker containing silver nitrate solution. (2mks)

20. a) State the Graham's law diffusion. (1mk)

b) The molar masses of gases W and X are 16.0 and 44.0 respectively. If the rate of diffusion of W through a porous material is $12\text{cm}^3\text{s}^{-1}$ calculate the rate of diffusion of X through the same material. (2mks)

21. The diagram below represents an experiment that was set up to investigate movement of ions during electrolysis.

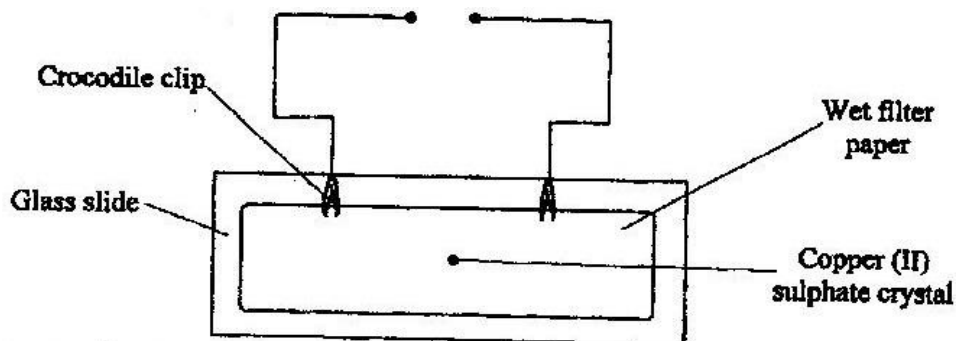

When the circuit was completed, it was noticed that a blue colour spread towards the right.

a) Explain this observation (2mks)

b) Write the equation for the reaction that occurred at the anode. (1mk)

22. The diagram below is part of a set up used in the laboratory preparation of a gas.

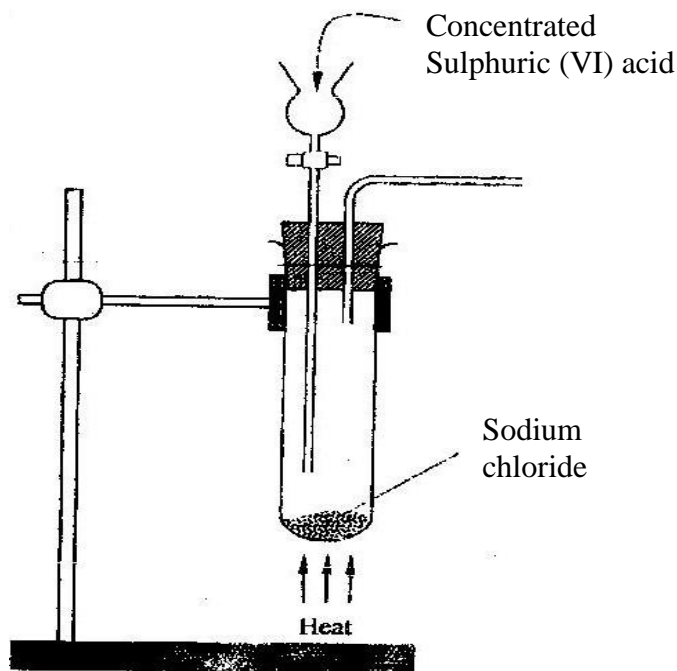

Complete the diagram to show how a dry sample of the gas can be collected.

(3mks)

23. In a closed system, aqueous iron (III) chloride reacts with sulphide gas as shown in the equation below.

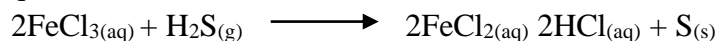

State and explain the observation that would be made if dilute hydrochloric acid is added to the system at equilibrium.

(2mks)

24. a) A radioactive substance emits three different particles. Give the symbol of the particle with the highest mass.

(1mk)

- b) (i) Find the values of Z_1 and Z_2 in the nuclear equation below

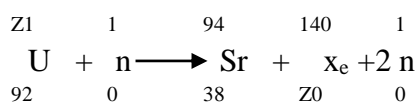

- iii) What type of nuclear reaction is represented in b (i) above?

(1mk)

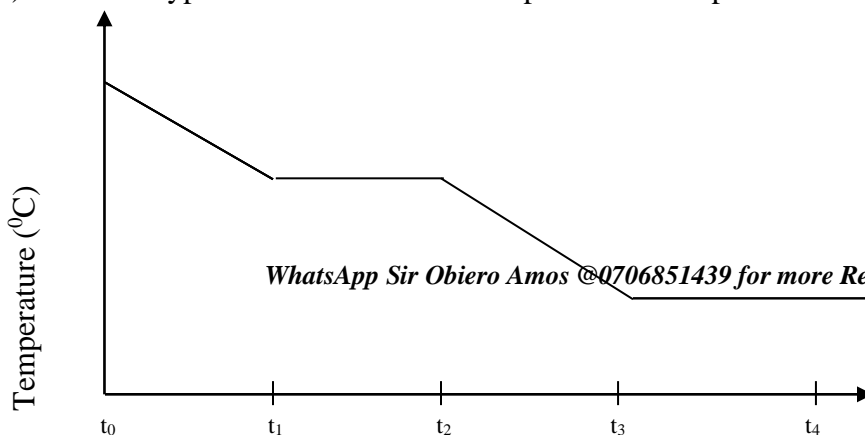

Time (minutes)

Give the name of the:

a) Process taking place between t_0 and t_1 . (1mk)

b) Energy change that occurs between t_3 and t_4

26. When solid B_1 was heated, a gas which formed a white precipitate when passed through lime water was produced. The residue was dissolved in dilute nitric (V) acid to form a colourless solution B_2 . When dilute hydrochloric acid was added to solution B_2 a white precipitate which dissolved on warming was formed.

a) Write the formula of the;

I Cation in solid B_1 (1mk)

II anion in solid B_1 (1mk)

b) Write an ionic equation for the reaction between the residue and dilute nitric (V) acid. (1mk)

27. In an experiment to determine the percentage of magnesium hydroxide in an anti-acid, a solution containing 0.50 g of the anti-acid was neutralized by 23.0 cm^3 of 0.010M hydrochloric acid (Relative formula mass of magnesium hydroxide = 58)

a) Mass of magnesium hydroxide in the anti-acid; (2mks)

b) Percentage of magnesium hydroxide in the anti-acid (1mk)

28. During the extraction of aluminium from its ores; the ore is first purified to obtain alumina.

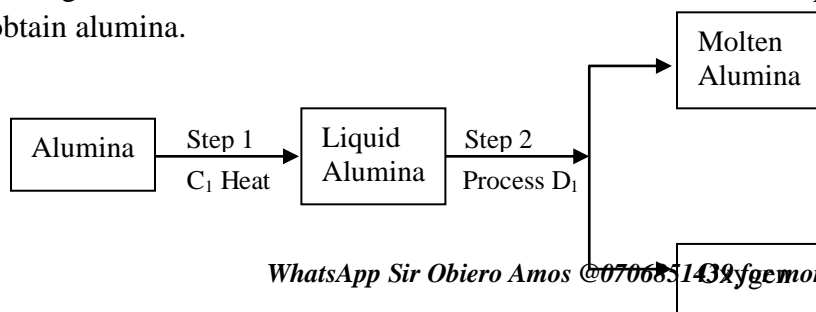

WhatsApp Sir Obiero Amos @0706831439 for more Resources

- a) Name
- (i) Substance C₁ (1mk)
- (ii) Process D₁ (1mk)
- b) Give two reasons why aluminium is used extensively in the making of cooking pans. (1mk)

29. A certain mass of a metal E₁ reacted with excess dilute hydrochloric acid at 25°C. The volume of hydrogen gas liberated was measured after every 30 seconds. The results were presented as shown in the graph below.

- a) Name one piece of apparatus that may have been used to measure the volume of gas liberated. (1mk)
- b) (i) On the same axis, sketch the curve that would be obtained if the experiment was repeated at 35°C. (1mk)
- (ii) Explain the shape of your curve in b(i) above. (1mk)

30. Crude oil contains sulphur. What would be the effect to the environment of using fuel containing sulphur? (1mk)

31. Study the flow chart below and answer the questions that follow.

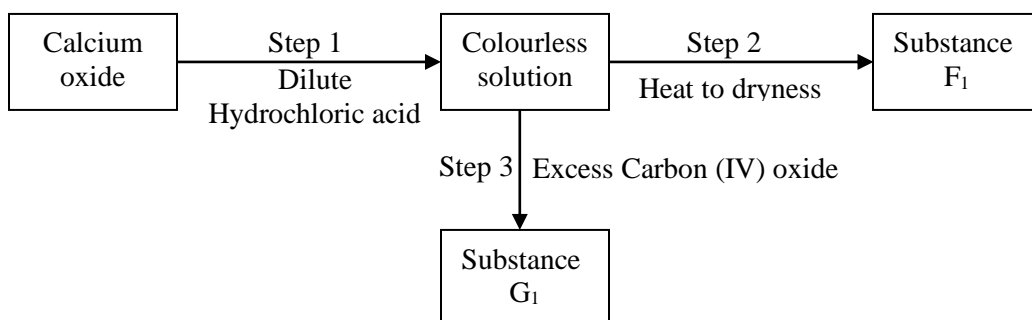

- a) Give the name of the process that takes place in step 1. (1mk)
- b) Give;

- (i) The name of substance G₁
- (ii) One use of substance F₁

CHEMISTRY PAPER 233/1
KCSE 2009 QUESTIONS

1. The ionization energies for three elements A, B and C are shown in the table below:

Element	A	B	C
Ionisation energy (kJ/mole)	519	418	494

- a) What is meant by ionization energy? (1 mk)
 - b) Which element is the strongest reducing agent? Give a reason. (2 mks)
2. Hardness of water may be removed by either boiling or addition of chemicals
- a) write an equation to show how boiling removes hardness of water. (1 mk)
 - b) name two chemicals that are used to remove hardness of water. (2 mks)

3. The atomic number of sulphur is 16.
Write the electron arrangement of sulphur in the following: (2 mks)

a) H_2S ;

b) SO_3^{2-}

4. An experiment was set up as shown in the diagram below:

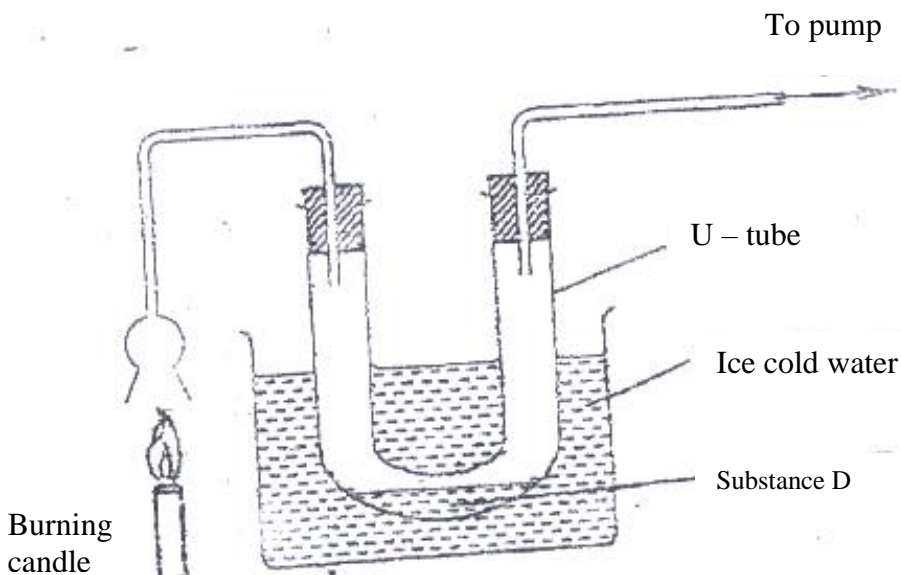

a) Identify substance D. (1 mk)

b) Describe how the other product of the burning candle could be prevented from getting into the environment. (2 mks)

5. In terms of structure and bonding, explain why the melting point of oxygen is much lower than that of sodium. (3 mks)

6. An isotope of element E has 34 neutrons and its mass number is 64. E forms a cation with 28 electrons. Write the formula of the cation with 28 electrons. Write the formula of the cation indicating the mass and atomic numbers. (1mk)

7. When aluminium oxide was electrolysed, 1800kg of aluminium metal

were obtained.

a) Write equation for the formation of aluminium metal (1 mk)

b) Calculate the quantity of electricity in faradays used (Al=27) (2 mks)

8. Using dots (.) and crosses (x) , show bonding in:

a) The compound formed when nitrogen reacts with fluorine
(Atomic numbers F=9, N=7); (1mk)

b) Sodium oxide.
(Atomic numbers Na= 11, O = 8) (1 mk)

9. a) what is meant by molar heat of solution? (1 mk)

b) The lattice energy of sodium bromide and hydration energies of sodium and bromide ions are: 733,406 and 335 kJmol⁻¹respectively.

i) Complete the energy cycle diagram below by inserting the values of ∇H_1 , ∇H_2 , and ∇H_3 (1 ½ mks)

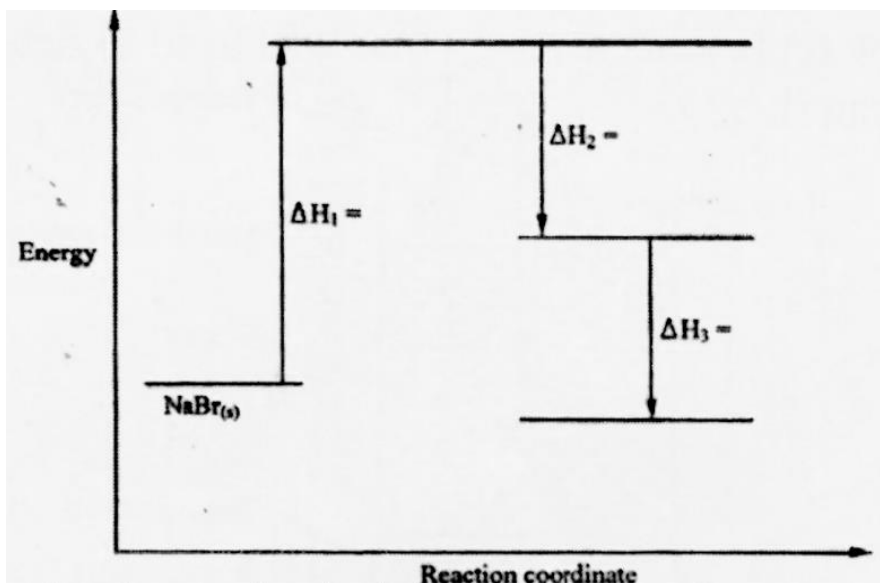

ii) Determine the molar heat of solution of solid sodium bromide. (½ mk)

10. Hydrogen and oxygen can be obtained by electrolysis of acidified water. Using equations for the reactions at the electrodes, explain why the volume of hydrogen obtained is twice that of oxygen. (2mks)

11. Starting with 50 cm³ of 2.8M sodium hydroxide, describe how a sample of pure sodium sulphate crystals can be prepared. (3 mks)

12. The standard reduction potentials of two half –cells are:

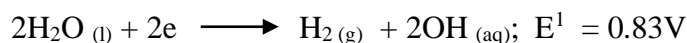
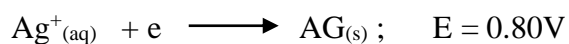

Draw a labelled diagram of an electro chemical cell that can be constructed using the two half –cells (3 mks)

13. When 8.53 of sodium nitrate were heated in an open test-tube the mass of oxygen gas produced was 0.83 g . Given the equation of the reaction as

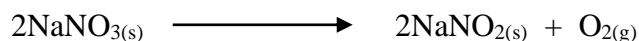

Calculate the percentage of sodium nitrate that was converted to sodium nitrite
(Na = 23.0 N = 14.0 O = 16.0) (3 mks)

14. a) Draw and name the structure of the compound formed when one mole of ethyne reacts with one mole of hydrogen bromide. (2mks)

b) Draw the structures of the alkynes whose molecular formula is C_4H_6 (1 mk)

15. A student used the set up shown in the diagram below in order to study the reactions of some metals with steam. The experiment was carried out for ten minutes

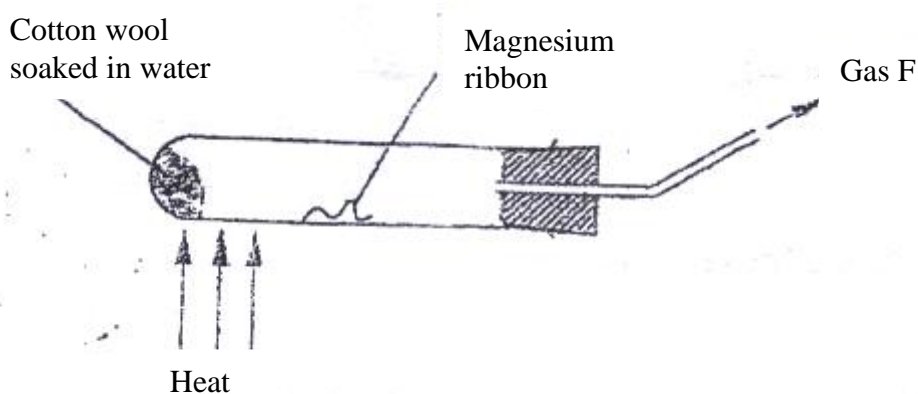

a) What observation would be made if gas F is ignited? (1 mk)

b) When the experiment was repeated using iron powder instead of magnesium ribbon very little gas F was obtained.

i) Give a reason for this observation (1 mk)

ii) What change in the conditions of the experiment should the student have made in order to increase the volume of gas F Produced? (1mk)

16. The solubility curve of potassium nitrate is shown below.
- a) Determine the solubility of potassium nitrate at 50°C (1 mk)
- b) Determine the molar concentration of saturated potassium nitrate at 50°C ($K=39.0$ $0= 16.0$ $N= 14.0$ and density of water 1 g/cm^3). (2 mks)

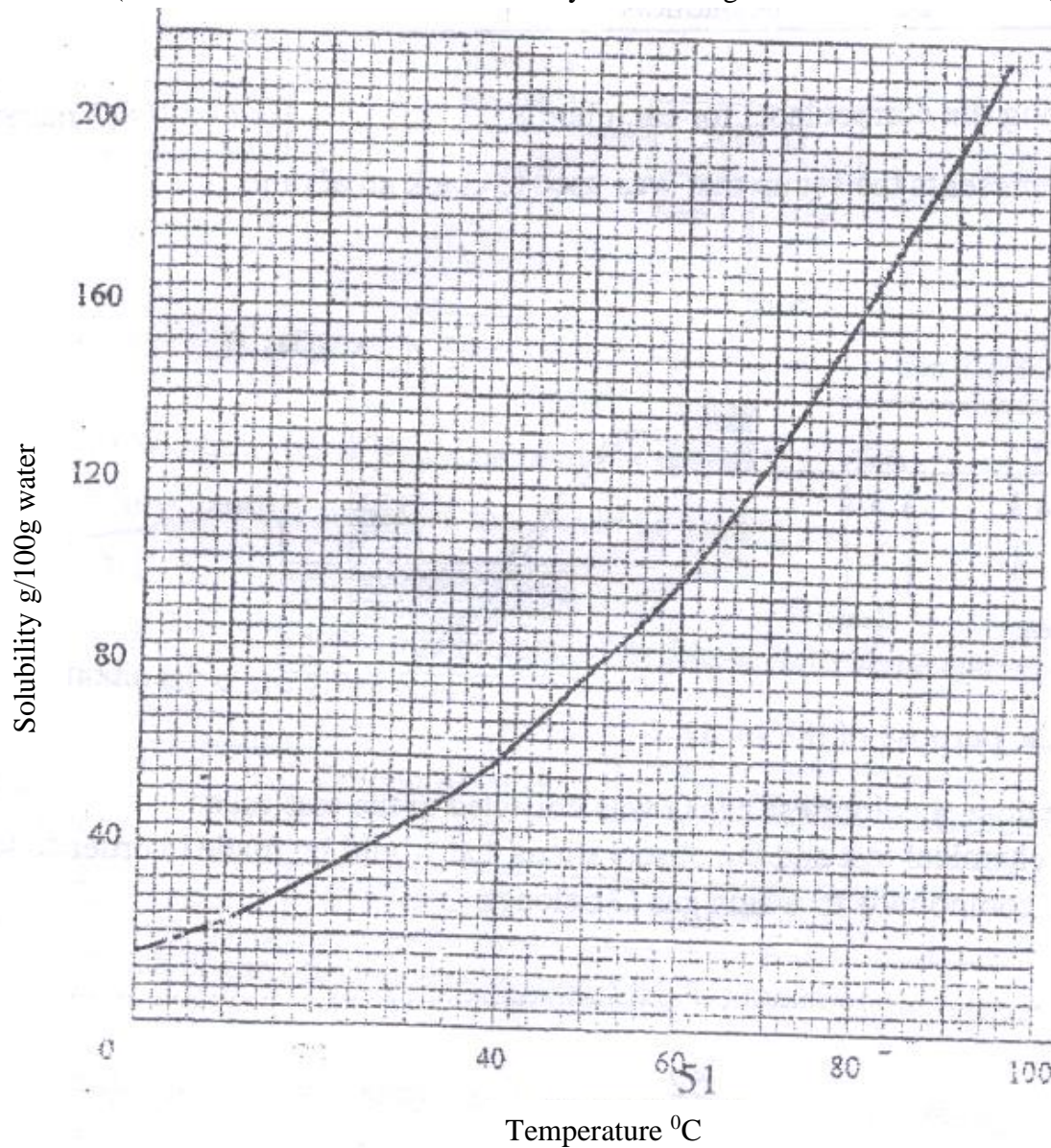

17. The structure of methanoic acid is

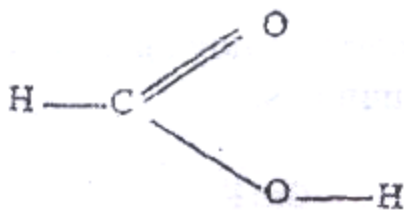

What is the total number of electrons used for bonding in a molecule of methanoic acid? Give reasons. (2 mks)

18. Bottles of sodium carbonate, sodium chloride and sugar have lost their labels. A student prepares and tests an aqueous solution of a sample from each bottle.

The results obtained are as shown in the table below.

Bottle	PH	Electrical Conductivity	Correct label
1	7	Conducts	
2	7	Does not conduct	
3	10	conducts	

Complete the table by filling the correct label for each bottle. (3 mks)

19. The figure below represents the set up that was used to crack an alkane.

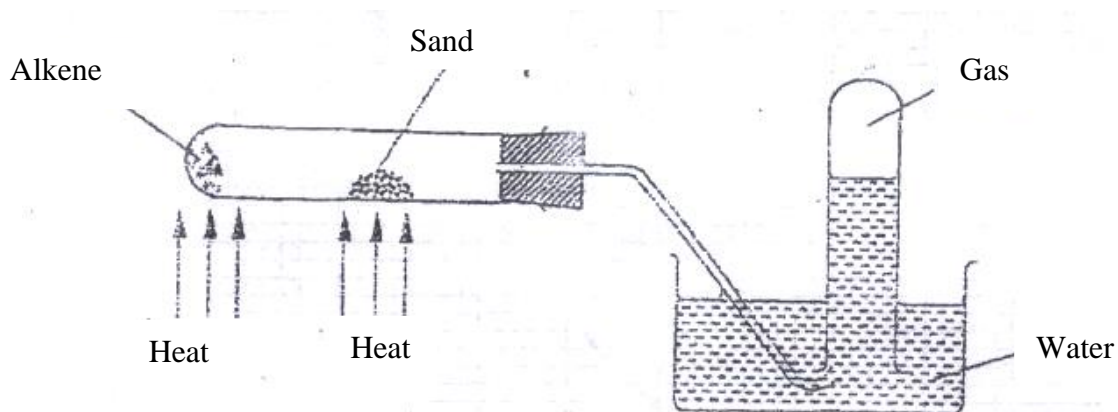

- a) What was the purpose of the sand? (1 mk)
- b) After some time, a colourless gas G collected in the test-tube. Describe a chemical test and the observations that would be made in order to identify the class of compounds to which gas G belongs. (2 mks)

20. Classify the following processes as either chemical or physical. (3 mks)

Process	Type of change
a) Heating copper (II) sulphate crystals	
b) Obtaining kerosene from crude oil	
c) Souring of milk	

21. Give the name of the product formed when magnesium reacts with phosphorus. (1 mk)
22. a student added very dilute sulphuric (VI) acid to four substances and recorded the observations shown in the table below.

Test	Substance	Gas given off
1	Sodium	Yes
2	Iron	No
3	Carbon	Yes
4	Copper	No

For which tests are the observations wrong? Explain (3 mks)

23. Use the flow chart below to answer the questions that follow.

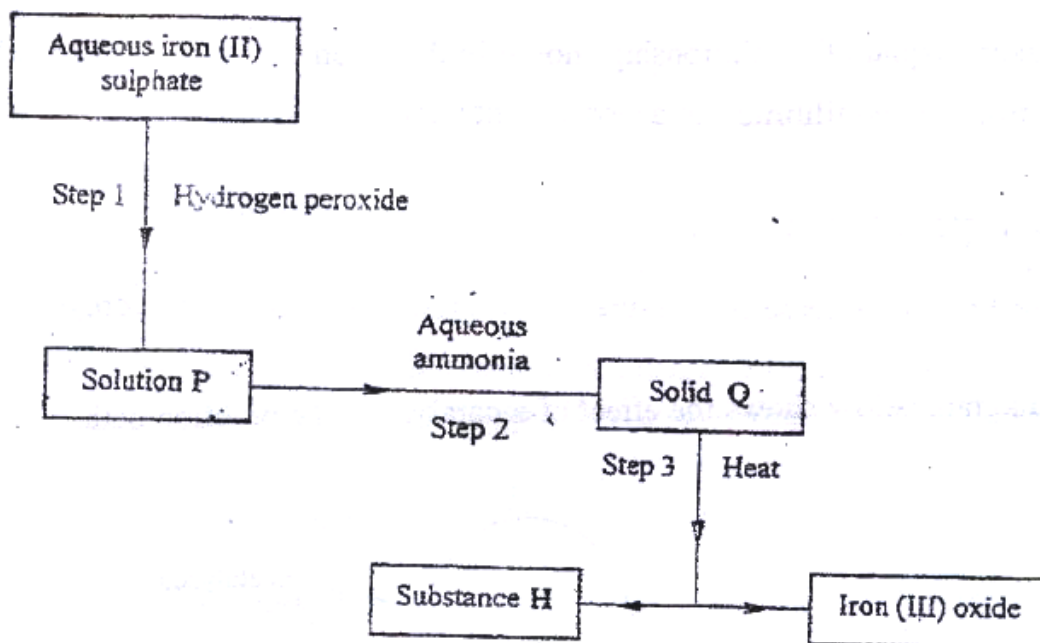

- a) What observation would be made in step I?

(1 mk)

b) Name another substance that could be used in step 2. (1 mk)

c) Give the name of substance H. (1 mk)

24. The boiling points of some compounds of hydrogen with some elements in groups 4 and 6 of the periodic table are given below.

Compound	Boiling point ($^{\circ}\text{C}$)	Compound	Boiling point ($^{\circ}\text{C}$)
CH_4	-164.0	H_2O	100.0
SiH_4	-112.0	H_2S	-61.0

a) Which of the compounds CH_4 and SiH_4 has stronger intermolecular forces? (1 mk)

b) Explain why the boiling points of H_2O and H_2S show different trends from that of CH_4 and SiH_4 (2mks)

25. For each of the following reactions, state the observation and write the formula of the Compound responsible for the observation:

a) Bromine water is added to aqueous potassium iodide; (1 ½ mks)

b) Excess aqueous ammonia is added to copper (II) hydroxide (precipitate). (1 ½ mks)

26. The graph below shows the relationship between pressure and the temperature of a gas in a fixed volume container.

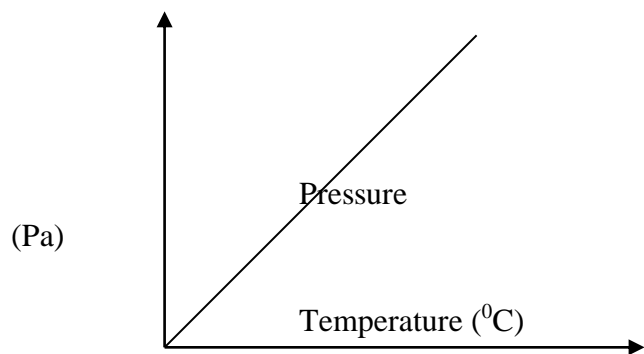

- a) State the relationship between pressure and temperature that can be deduced from the graph. (1 mk)
- b) Using kinetic theory, explain the relationship shown in the graph. (2 mks)

27. The following reaction is in equilibrium in a closed container

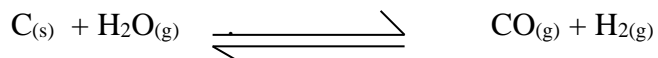

State giving reasons how an increase in pressure would affect the amount of hydrogen. (2 mks)

28. The energy level diagram below shows the effect of a catalyst on the reaction path.

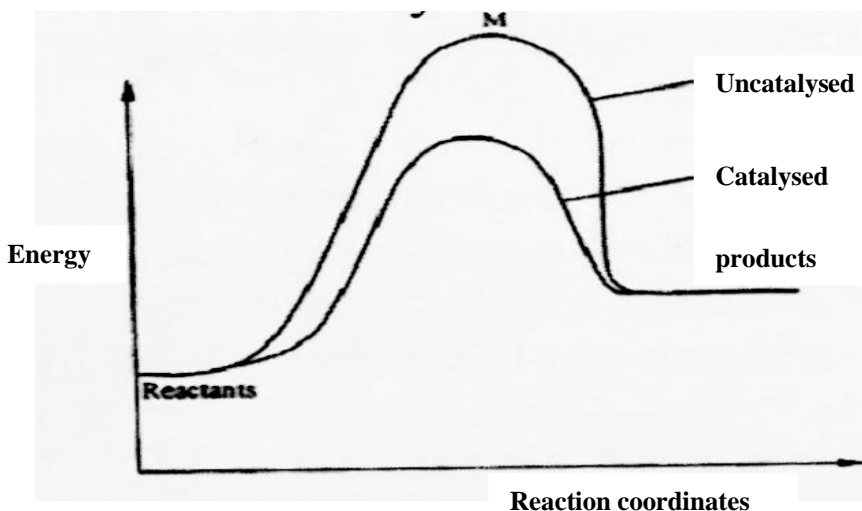

- a) What does point M represent? (1 mk)

CHEMISTRY PAPER 233/1

KCSE 2010 QUESTIONS

1.
 - a) Distinguish between a deliquescent and a hygroscopic substance. (2 mks)
 - b) Give **one** use of hygroscopic substance in the laboratory. (1 mk)

2. a) What is meant by the terms: (2 mks)
 - a. element
 - b. atomic number
b) The formula for a chloride of titanium is TiCl_3 . What is the formula of its sulphate? (1 mk)

3. What is the name given to each of the following:
 - a) Ability of a metal to be made into a wire: (1 mk)
 - b) Minimum energy required for a chemical reaction to start; (1 mk)
 - c) Type of force that hold atoms of noen together? (1 mk)

4. Draw the structure and give the name of the three alkaline having molecular formula C_5H_{10} (3 mks)

5. Hydrate cobalt(II) chloride exists as pink crystals and anhydrous cobalt(II) chloride is a blue powder. Describe a laboratory experiment that can be used to show that the action of heat on hydrated cobalt(II) chloride is a reversible reaction. (3 mks)

6. Aluminium oxide reacts with both acids and bases.
 - a) Write an equation for the reaction between aluminium oxide and hydrochloric acid. (1 mk)

- b) Using the equation in (a) above, calculate the number of moles of hydrochloric acid that would react completely with 153.0g of aluminium oxide.
(AL = 27.0, O= 16.0) (2 mks)

7. Complete the table below by writing the product formed at the electrodes during the electrolysis of the electrolytes given in the table. (3 mks)

Electrolyte	Product at anode	Product at cathode
Aqueous sodium sulphate using inert electrodes	oxygen (1/2 mk)	Hydrogen (1/2 mk)
Aqueous copper(II) sulphate using copper electrodes	Copper ions (1 mk)	Copper metal (1 mk)

8. The pressure of nitrogen gas contained in a 1dm^3 cylinder at -196°C was 10^7 Pascals. Calculate the:
- a) Volume of the gas at 25°C and 10^5 Pascals. (1 ½ mks)
- b) Mass of nitrogen gas(Molar volume of gas is 24dm^3 , N = 14.0) (1 ½ mks)
9. Carbon -14, $^{14}_6\text{C}$, is used in carbon dating. It decays to form nitrogen, $^{14}_7\text{N}$. The graph below shows the amount of carbon -14 left in a sample against its age in years.

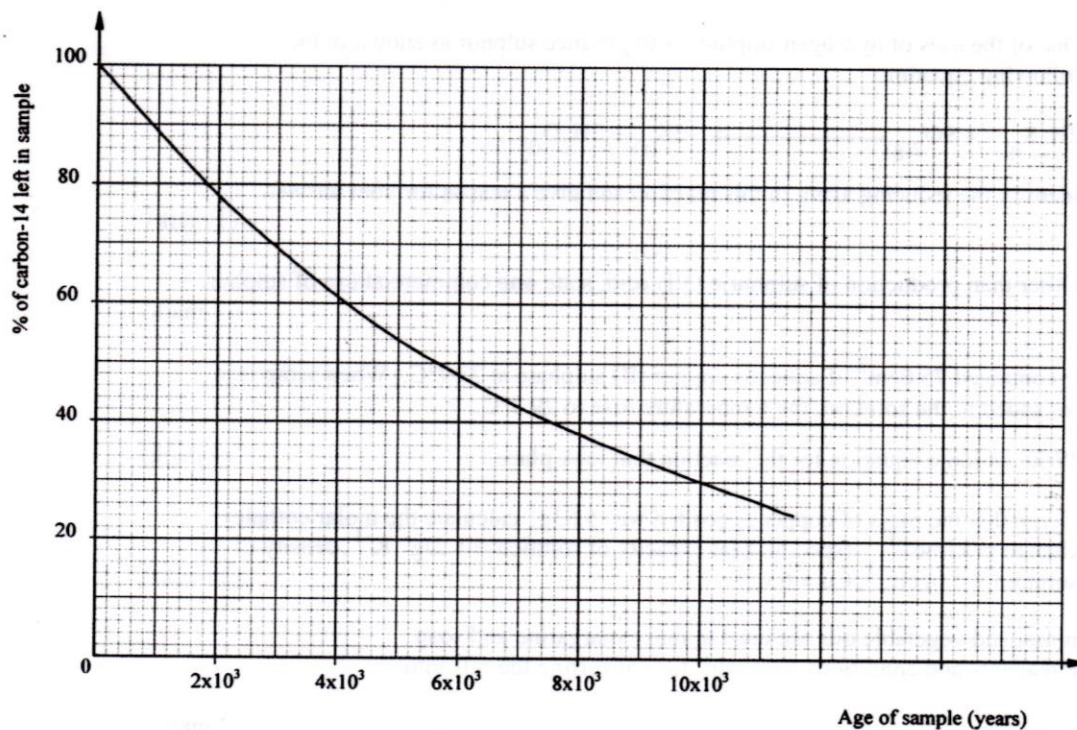

- a) Write a nuclear equation for the decay process of carbon -14. (1 mk)
- b) From the graph, determine the;
- Half-life of carbon -14; (1 mk)
 - Percentage of carbon -14 in a sample whose age is 1950 years. (1 mk)

10. The figure below shows an energy cycle.

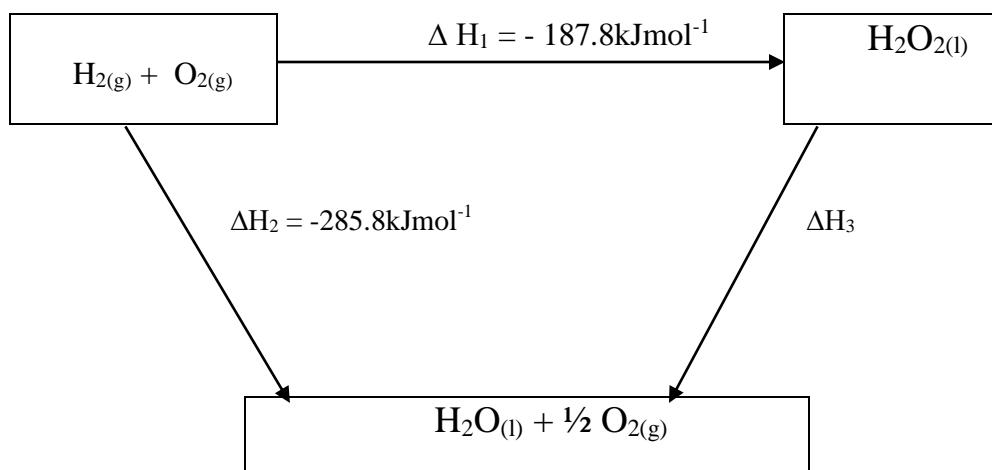

- a) Give the name of the enthalpy change ΔH_1 . (1 mk)
b) Determine the value of ΔH_3 . (2 mks)

11. Hydrogen sulphide is a highly toxic and flammable gas. It is normally prepared in a fume chamber.

- a) Name **two** reagents that can be used to prepare hydrogen sulphide in the laboratory. (1 mk)
b) One of the uses of hydrogen sulphide is to produce sulphur as shown in the following equation;

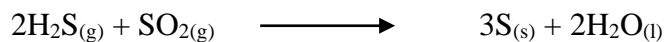

Identify the reducing agent in this reaction and give a reason for your answer. (1 mk)

- c) Other than production of sulphuric(IV) acid, state **one** commercial use of sulphur. (1 mk)

12. A beaker contained 75.0cm^3 of aqueous copper (II) sulphate at 23.7°C . when scrap iron metal was added to the solution, the temperature rose to 29.3°C .

- a) Write an ionic equation for the reaction that took place. (1 mk)

- b) Given that the mass of copper deposited was 5.83g, calculate the molar enthalpy change in kJmol^{-1} . (specific heat capacity of solution = $4.2\text{Jg}^{-1}\text{K}^{-1}$, density of solution 1.0gcm^{-3} , $\text{Cu} = 63.5$) (2 mks)

13. Some animal and vegetable oils are used to make margarine and soap. Give the reagents and conditions necessary for converting the oils into:

- a) Margarine (2 mks)
b) Soap (1 mk)

14. Using electrons in the outermost energy level, draw the dot (.) and cross (x) diagrams for the molecules H_2O and C_2H_4 . ($\text{H} = 1$, $\text{C} = 6$, $\text{O} = 8$) (2 mks)

- i) H_2O
ii) C_2H_4
b) The formula of a complex ion is $\text{Zn}(\text{NH}_3)_4^{2+}$. Name the type of bond that is likely to exist between zinc and ammonia in the complex ion. (1 mk)

15. Carbon (II) oxide is described as a “silent killer”
- a) State **one** physical property of carbon (II) oxide that makes it a “silent killer” (1 mk)
 - b) State and explain **one** chemical property that makes carbon (II) oxide poisonous to human beings (2 mks)
16. A sample of fertilizer is suspected to be calcium ammonium nitrate. Describe chemical tests for each of the following ions in the sample:
- a) Calcium ions; (2 mks)
 - b) Ammonium ions. (1 mk)
17. Analysis of a compound showed that it had the following composition: 69.42% carbon, 4.13% hydrogen and the rest oxygen.
- a) Determine the empirical formula of the compound. (C = 12.0, H = 1.0, O = 16.0) (2 mks)
 - b) If the mass of one mole of the compound is 242, determine its molecular formula (1 mk)
18. The diagram below represents set up for large scale manufacture of hydrochloric acid. Study it and answer the questions that follow.

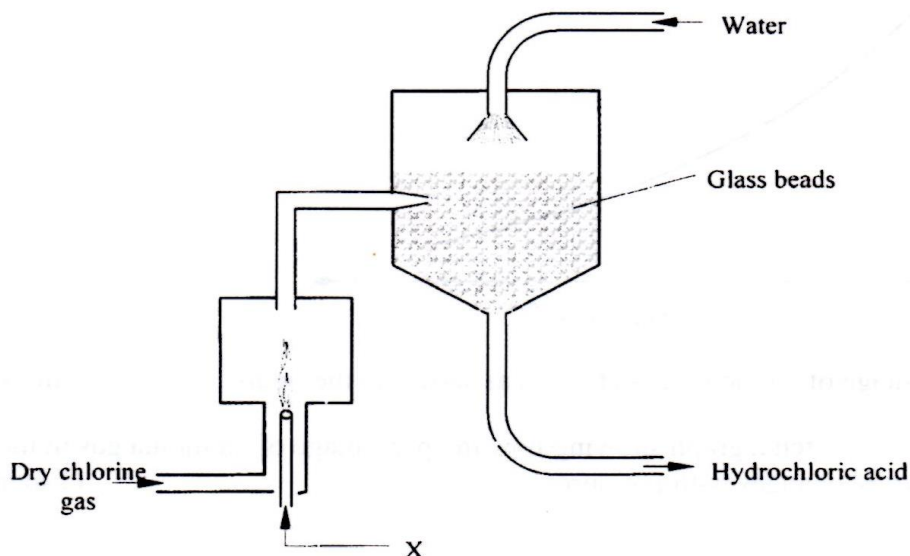

- Name substance X (1 mk)
- What is the purpose of the glass beads? (1 mk)
- Give two uses of hydrochloric acid. (1 mk)

19. The half equations involved in a cell are:

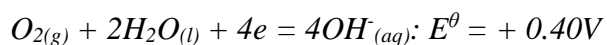
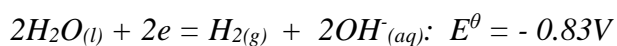

- Write the overall equation for the electrochemical cell. (1 mk)
- Calculate the e.m.f. generated by a battery consisting of ten cells. (1 mk)
- State **one** environment advantage of using these cells in spacecrafts. (1 mk)

20. In an experiment to prepare nitrogen (I) oxide, ammonium nitrate was gently heated in a flask.

- Write the equation for the reaction that took place in the flask. (1 mk)
- State and explain how the gas was collected. (1 mk)
- A sample of the gas was tested with damp blue and red litmus papers. What observations were made?

21. The use of CFCs has been linked to depletion of the ozone layer.

- a) What does CFC stand for? (1 mk)
- b) Explain the problem associated with the depletion of the ozone layer (1 mk)
- c) State another environment problem caused by CFCs (1 mk)

22. Nitrogen and hydrogen react to form ammonia gas as shown in the following equation:



- a) The figure below shows how the percentage of ammonia gas in the equilibrium mixture change with temperature.

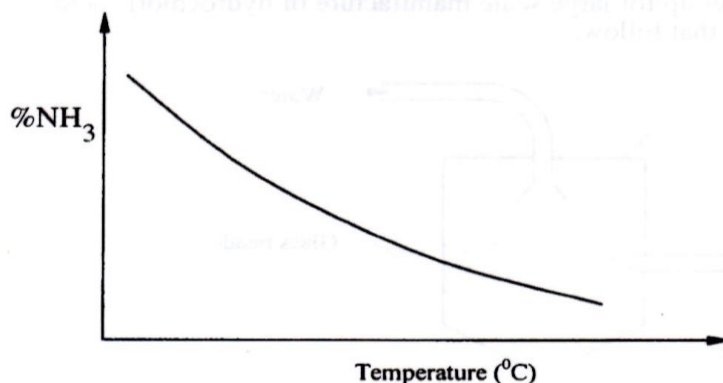

Explain why the percentage of ammonia gas change as shown in the figure. (2 mks)

- b) On the axes below, sketch a graph showing how the percentage of ammonia gas in equilibrium mixture changes with pressure.

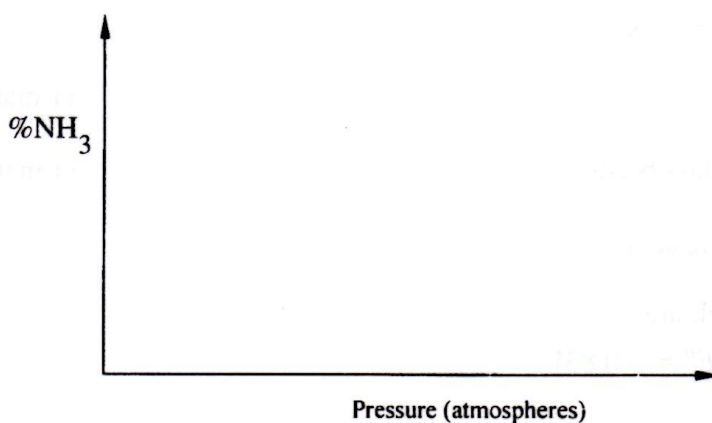

23. The curves below shows how the electronic conductivity of hydrochloric and ethanoic acids vary with concentration.

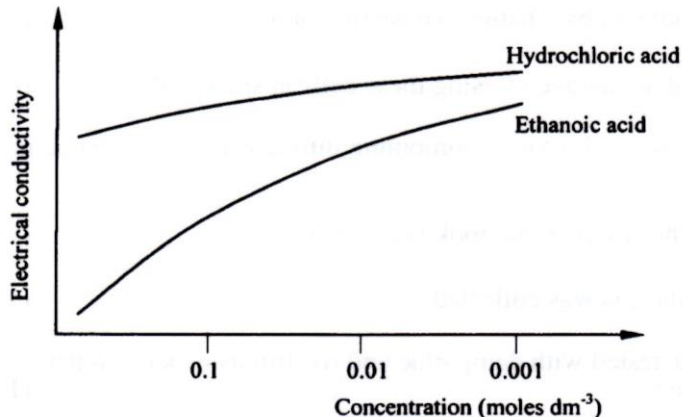

Explain why the electrical conductivity of 0.01M hydrochloric acids is higher than that of 0.01M ethanoic acid. (2 mks)

24. Describe how a solid sample of the double salt, ammonium iron(II) sulphate, can be prepared using the following reagents; Aqueous ammonia, sulphuric(VI) acid and iron metal. (3 mks)

25. A sample of river water was divided into three portions. The table below shows the test carried out on the portions and the observations made.

Test	Observation	Inference
To the first portion, 1cm ³ of soap solution was added	No lather formed	
The second portion was boiled, cooled and 1cm ³ of soap solution was added	No lather formed	
To the third portion, 3cm ³ of aqueous sodium carbonate was added, the mixture filtered and 1cm ³ of soap solution added to the filtrate.	Lather formed immediately	

Complete the table by filling in the inferences. (3 mks)

26. A water trough, aqueous sodium hydroxide, burning candle, watch glass and a graduated gas jar were used in an experimental set up to determine the percentage of active part of air. Draw a labeled diagram of the set up at the end of the experiment. (3 mks)

27. The atomic numbers of phosphorus, sulphur and potassium are 15, 16 and 19 respectively. The formulae of their ions are P^{3-} , S^{2-} and K^{+} . These ions have the same number of electrons.

a) Write the electron arrangement for the ions. (1 mk)

b) Arrange the ions in the order of increasing ionic radius starting with the smallest. Give a reason for the order. (2 mks)

CHEMISTRY PAPER 233/1
K.C.S.E. 2011 QUESTION

1. (a) What name is given to the process by which alcohol is formed from a carbohydrate? (1 mk)
- (b) Explain why the solubility of ethane in water is lower than that of ethanol. (2 mks)
2. Complete the nuclear equation below:
- (a) ${}_{53}^{131}\text{I} \rightarrow {}_{54}^{131}\text{Xe} + \dots\dots\dots$ (1mk)
- (b) The half-life of ${}_{53}^{131}\text{I}$ is 8 days
- Determine the mass of ${}_{53}^{131}\text{I}$ remaining if 50 grammes decayed for 40 days. (1 mk)
- (c) Give one harmful effect of radioisotopes. (1mk)
3. A mixture contains ammonium chloride, copper (II) oxide and sodium chloride. Describe how each of the substances can be obtained from the mixture. (3mks)
4. The set up below shows how nitrogen gas is prepared in a laboratory.

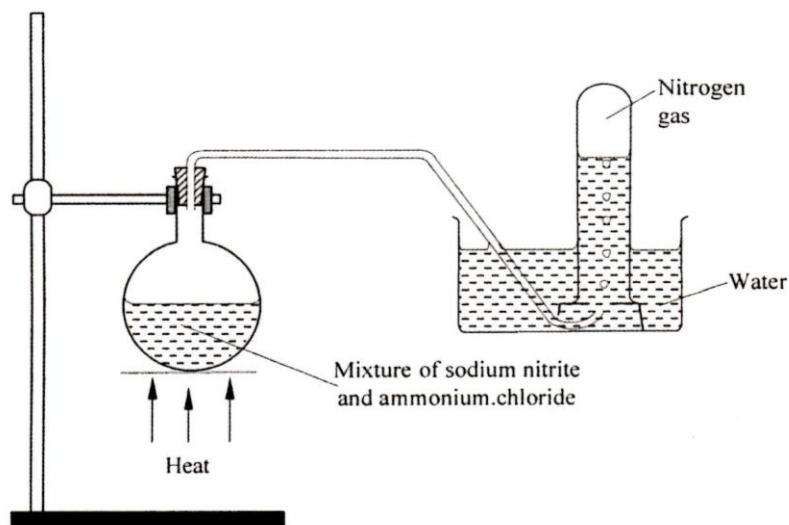

(a) Describe how nitrogen gas is formed in the flask. (2mk)

(b). Nitrogen is inert, state one use of the gas based on this property. (1 mk)

5. The diagram below represents part of the periodic table. Use it to answer the questions that follow.

M				Q				
T	V		W					

a) Write the electronic arrangement for the stable ion formed by W. (1mk)

(b) Write an equation for the reaction between V and Q. (1mk)

(c) How do the ionisation energies of the elements M and T compare?

Explain.

6. A certain mass of gas occupies 0.15dm^3 at 293K and $98,648.5\text{Pa}$. Calculate its Volume at $101,325\text{Pa}$ and 273K . (2 mks)

7. When lead(II) nitrate is heated, one of the products is a brown gas.
- (a) Write the equation of the reaction that occurs . (1 mk)
- (b) If 0.290dm^3 of the brown gas was produced, calculate the mass of the lead(II) nitrate that was heated. (R.F.M of lead (II) nitrate = 331; Molar gas volume = 24dm^3). (2 mks)
8. (a) What is meant by a strong acid? (1 mk)
- (b) In an experiment 40cm^3 of 0.5M hydrochloric acid was reacted with excess sodium carbonate and the volume of carbon (IV) oxide produced recorded with time. In another experiment, the same volume and concentration of ethanoic acid was also reacted with excess sodium carbonate and the volume of carbon (IV) oxide produced recorded with time.

On the grid below, sketch and label the curves if the volumes of carbon (IV) oxide were plotted against time. (2 mks)

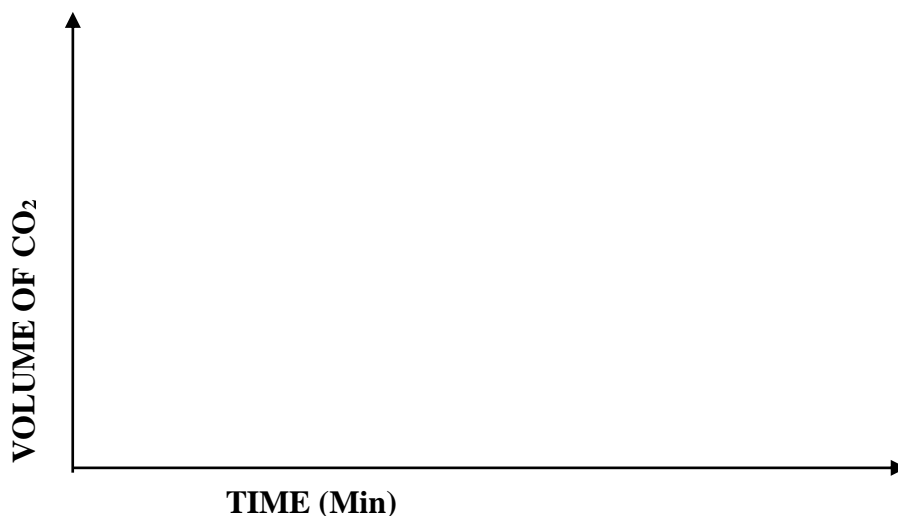

9. State two reasons why hydrogen is not commonly used as a fuel. (2mk)
10. During a class experiment, chlorine gas was bubbled into a solution of potassium iodide.
- (a) State the observations made. (1mk)

(b) Using an ionic equation, explain why the reaction is redox . (2mk)

11. Exhaust fumes of some cars contain carbon(II)oxide and other gases. (1mk)

(a) Explain how carbon (II) oxide is formed in the internal combustion engines.

(b) Name two gases other than carbon (II) oxide that are contained in exhaust fumes and are pollutants. (2 mks)

12. Sodium hydroxide can be prepared by the following methods; I and II.

I. Sodium metal $\xrightarrow{\text{Cold water}}$ Sodium hydroxide + Hydrogen

II. Concentrated sodium chloride $\xrightarrow{\text{process A}}$ Sodium hydroxide + Chlorine + Hydrogen

(a) Name the precaution that needs to be taken in method I. (1 mk)

(b) Give the name of process A. (1 mk)

(c) Give one use of sodium hydroxide, (1 mk)

13. Distinguish between the terms deliquescent and efflorescent as used in chemistry (2 mk)

14. Two organic compounds P and Q decolourise acidified potassium manganate (VII) solution but only P reacts with sodium metal to give a colourless gas. Which homologous series does compound P belong? Give a reason. (2 mks)

15. Soap dissolves in water according to the equation below;

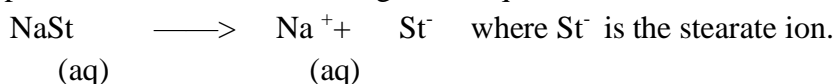

(a) Write the formula of the scum formed when soap is used in hard water. (1 mk)

(b) Write the ionic equation for the reaction that occurs when sodium carbonate is used to remove hardness in water. (1 mk)

16. Ethanoic acid and ethanol react as shown in the equation below:

Other than warming, how would the state of equilibrium be established within a short time? (1 mk)

17. The set up below was used to prepare a gas and study some of its properties.
Study it and answer the questions that follow:

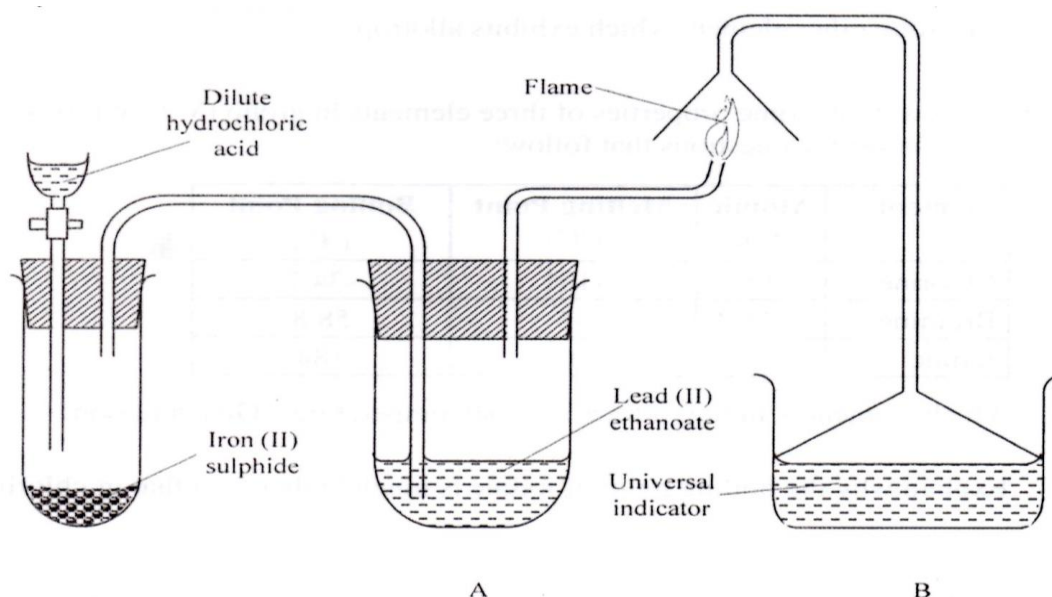

- (a) State and explain the observations made in the:
- tube labelled A; (1 mk)
 - beaker labelled B.
- (b) State one precaution that should be taken when carrying out this experiment. (1 mk)
18. Under certain conditions, chlorine gas reacts with sodium hydroxide to form sodium hypochlorite.
- Name the conditions under which sodium hydroxide reacts with chlorine to form sodium hypochlorite. (1 mk)
 - State two uses of sodium hypochlorite. (2 mks)
19. 50kg of ammonium sulphate $(\text{NH}_4)_2\text{SO}_4$ and 30kg of urea $\text{CO}(\text{NH}_2)_2$ fertilizers were applied in two equal sizes of plots A and B to enrich their nitrogen content.

Show by working, which plot was more enriched with nitrogen. (N =14;S = 32; O = 16; C = 12; H = 1) (3 mks)

20. Describe how the P^H of anti-acid (Actal) powder can be determined in the laboratory (2 mks)

21. Graphite is one of the allotropes of carbon.
 (a) Name one other element which exhibits allotropy. (1 mk)
 (b) Explain why graphite is used in the making of pencil leads. (2 mks)

22. The table below gives some properties three elements in group (VII) of the periodic table .Study it and answer the questions that follow:

Element	Atomic No.	Melting Point (°C)	Boiling Point (°C)
Chlorine	17	101	-34.7
Bromine	35	-7	58.8
Iodine	53	114	184

(a) Which element is in liquid form at room temperature? Give a reason. (1 mk)
 (b) Explain why the boiling point of iodine is much higher than that of chlorine. (2 mks)

23. The thermal chemical reaction between carbon and sulphur is as shown by the equation below:



On the grid below, sketch and label the energy level diagram for the reaction. (2 mks)

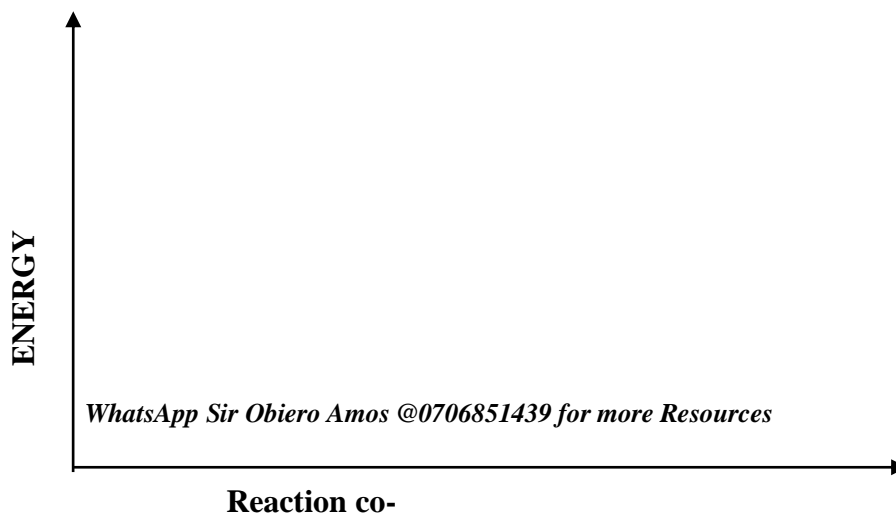

24. The table below gives the number of electrons, protons and neutrons in substances X, Y and Z. Study it and answer the questions that follow.

Substance	Electrons	Protons	Neutrons
X	10	10	10
Y	10	8	10
Z	8	8	8

- (a) Which letter represents an ion? (1 mk)
- (b) Which of the substances are isotopes? Give a reason. (2mk)
- 25 (a) State the Gay Lussac's Law. (1 mk)
- (b) 10cm^3 of a gaseous hydrocarbon, C_2H_x required 30cm^3 of oxygen for complete combustion. If steam and 20cm^3 of carbon (IV) oxide were produced, what is the value of X? (2 mks)
26. The data given below was recorded when Metal M was completely burnt in air. M is not the actual symbol of the metal. (R.A.M; M = 56, O = 16)
 Mass of empty crucible and lid = 10.240g
 Mass of crucible, lid and metal M = 10.352g
 Mass crucible, lid and metal oxide = 10.400g
- (a) Determine the mass of:
- (i) Metal M (1/2mk)
- (ii) oxygen. (1/2mk)
- (b) Determine the empirical formula of the metal oxide. (2 mks)
27. The flow chart below shows some processes involved in the extraction

of zinc metal:

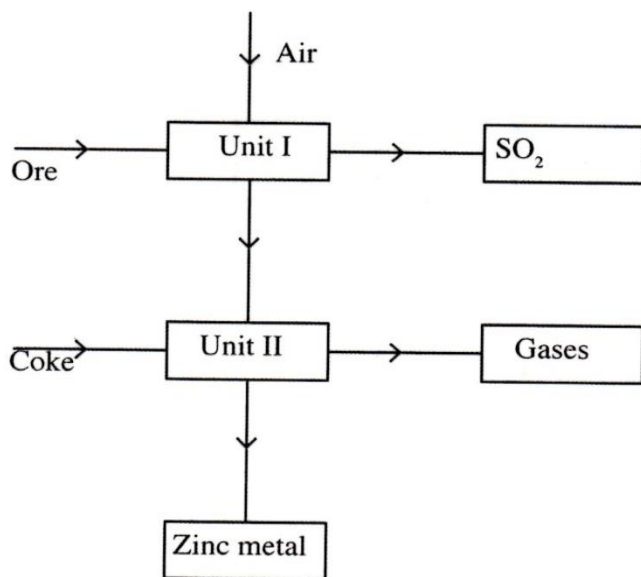

- a) Name one ore from which zinc is extracted. (1 mk)
- b) Write the equation of the reaction taking place in unit II (1 mk)
- c) Name two uses of zinc metal. (1 mk)

28. The diagram below shows the bonding between aluminium chloride and ammonia.

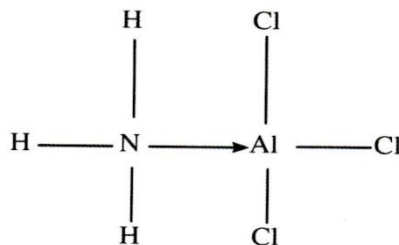

- (a) Name the types of bonds that exist in the molecule. (1mk)

128

1

(b) How many electrons are used for bonding in the molecule? (1 mk)

29. Explain why the following substances conduct an electric current.

(a) Magnesium metal. (1mk)

(b) Molten magnesium chloride. (1mk)

30. A sample of river water is suspected to contain zinc and sulphate ions.

Describe how the presence of zinc ions and sulphate ions can be established. (3 mks)

31. What name is given to elements which appear in group (II) of the periodic table?

(1mk)

CHEMISTRY PAPER 233/1

K.C.S.E. 2012 QUESTIONS

1. Charcoal is a fuel that is commonly used for cooking. When it burns it forms two oxides.

(a) Name the **two** oxides. (2 mks)

(b) State **one** use of any of the two oxides. (1 mk)

2. Iron (III) oxide was found to be contaminated with copper (II) sulphate. Describe how a pure sample of iron (III) oxide can be obtained. (3 mks)

3. In an experiment, dry hydrogen gas was passed over heated Lead (II) Oxide as shown in the diagram below.

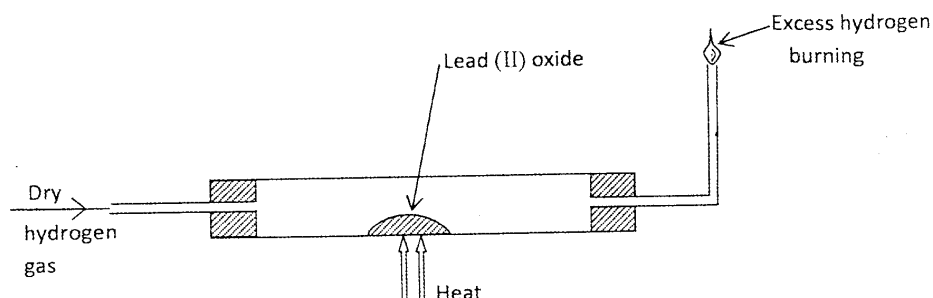

State and explain the observations made in the combustion tube. (3 mks)

4. The table below shows properties of some elements **A**, **B**, **C** and **D** which belong to the same period of the periodic table. The letters are not the actual symbols of the elements.

Element	A	B	C	D
Mp (°C)	1410	98	-101	660
Atomic radii (nm)	0.117	0.186	0.099	0.143
Electrical conductivity	Poor	Good	Non conductors	Good

(a) Arrange the elements in the order they would appear in the period. Give a reason. (2 mks)

(b) Select the metallic element which is the better conductor of electricity. Give a reason. (1 mk)

5. A sample of water in a beaker was found to boil at 101.5°C at 1 atmospheric pressure.

Assuming that the thermometer was not faulty, explain this observation. (1 mk)

6. Study the information in the table below and answer the questions that follow:

Salt	Solubility (g/100g water)	
	at 40°C	at 60°C
CuSO ₄	28	38
Pb(NO ₃) ₂	79	98

A mixture containing 35g of CuSO₄ and 78g of Pb(NO₃)₂ in 100g of water at 60°C was cooled to 40°C.

- (a) Which salt crystallised out? Give a reason (2 mks)
- (b) Calculate the mass of the salt that crystallised out. (1 mk)
7. Ammonium ion has the following structure:

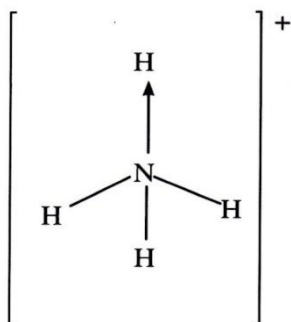

Label on the structure:

- (a) covalent bond; (1 mk)
- (b) coordinate (dative) bond. (1 mk)
8. 10cm³ of concentrated sulphuric (VI) acid was diluted to 100cm³. 10cm³ of the resulting solution was neutralised by 36cm³ of 0.1M sodium hydroxide solution. Determine the mass of sulphuric (VI) acid that was in the concentrated acid (S = 32.0; H = 1.0; O = 16.0). (3 mks)
9. 120g of iodine - 131 has a half life of 8 days and decays for 32 days. On the grid provided, plot a graph of the mass of iodine - 131 against time. (3 mks)

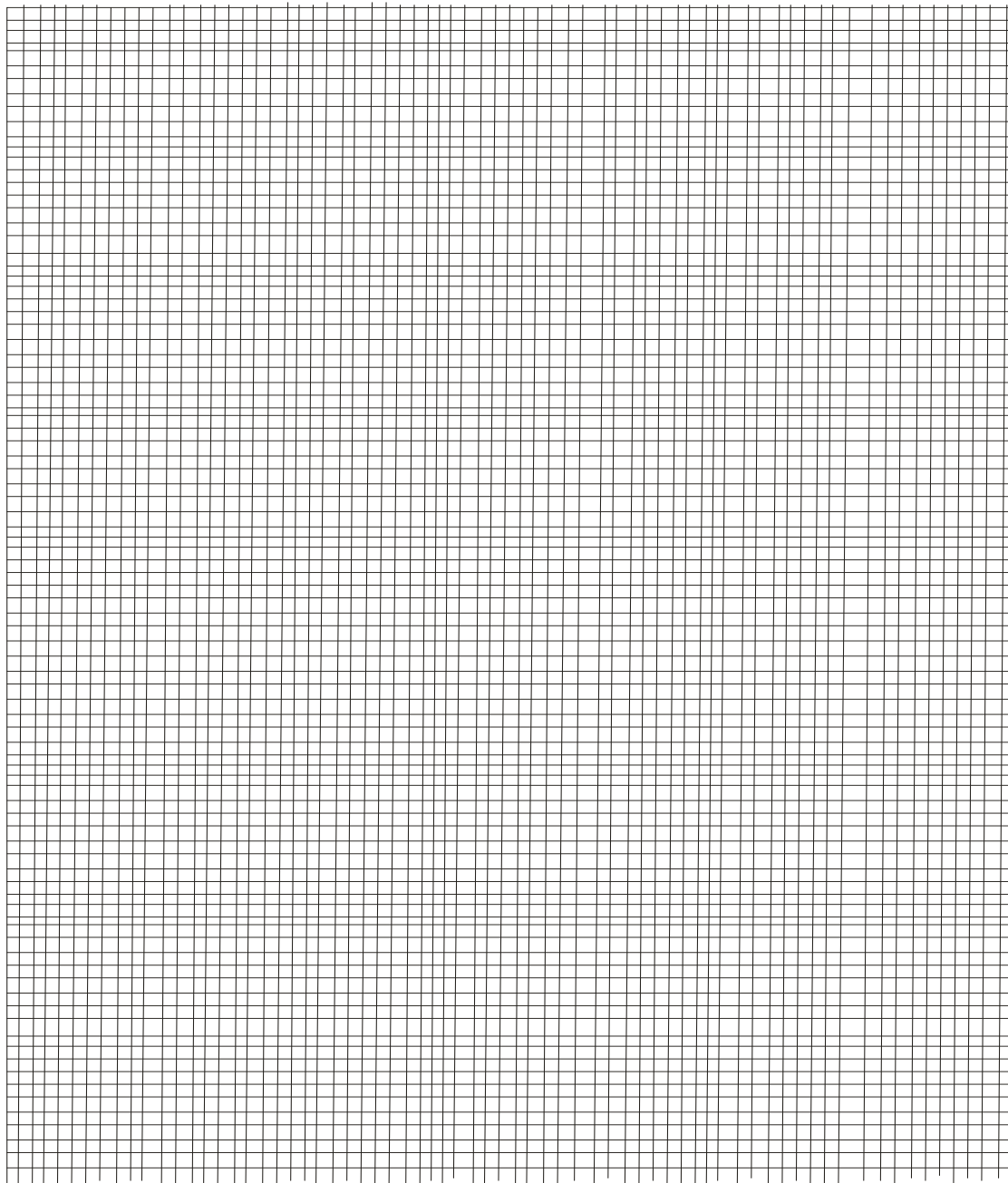

10. (a) Name **two** cations that are present in hard water. (1 mk)
- (b) Explain how the ion exchange resin softens hard water. (2 mks)
11. The empirical formula of A is CH_2Br . Given that 0.470g of A occupies a volume of 56cm^3 at 546K and 1 atmospheric pressure, determine its molecular formula. (H = 1.0, C = 12.0, Br = 80.0, molar gas volume at STP = 22.4 dm^3). (3 mks)

12. Study the flow chart below and answer the questions that follow.

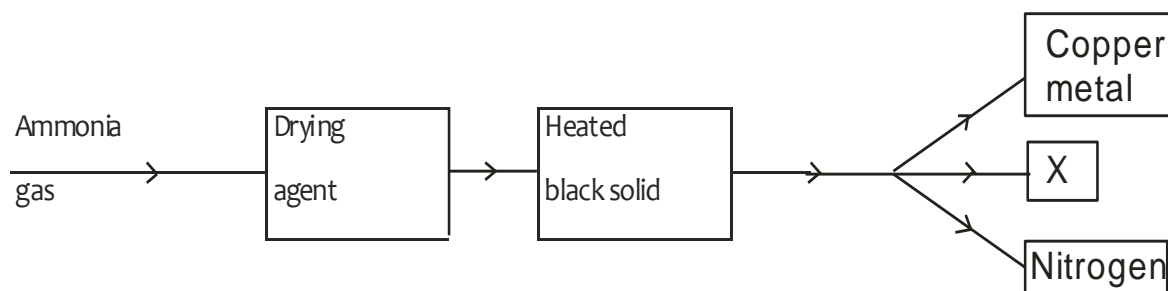

- (a) Name a suitable drying agent for ammonia. (1 mk)
- (b) Describe one chemical test for ammonia. (1 mk)
- (c) Name X. (1 mk)

13. A dynamic equilibrium is established when hydrogen and carbon (IV) oxide react as shown below:

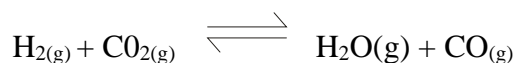

What is the effect of adding powdered iron catalyst on the position of the equilibrium?
Give a reason. (2 mks)

14. Distinguish between ionisation energy and electron affinity of an element. (2 mks)

15. Below is a representation of an electrochemical cell.



- (a) What does // represent? (1 mk)
- (b) Given the following:

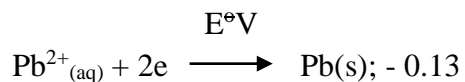

Calculate the E.M.F of the electrochemical cell. (2 mks)

16. Use the following information on substances S, T, V and hydrogen to answer

the questions that follow:

- (i) T displaces V from a solution containing V ions.

 - (ii) Hydrogen reacts with the heated oxide of S but has no effect on heated oxide of V.
- (a) Arrange substances S, T, V and hydrogen in the order of increasing reactivity. (2 mks)
- (b) If T and V are divalent metals, write an ionic equation for the reaction in (i) above. (1 mk)

17 Study the energy level diagram below and answer the questions that follow.

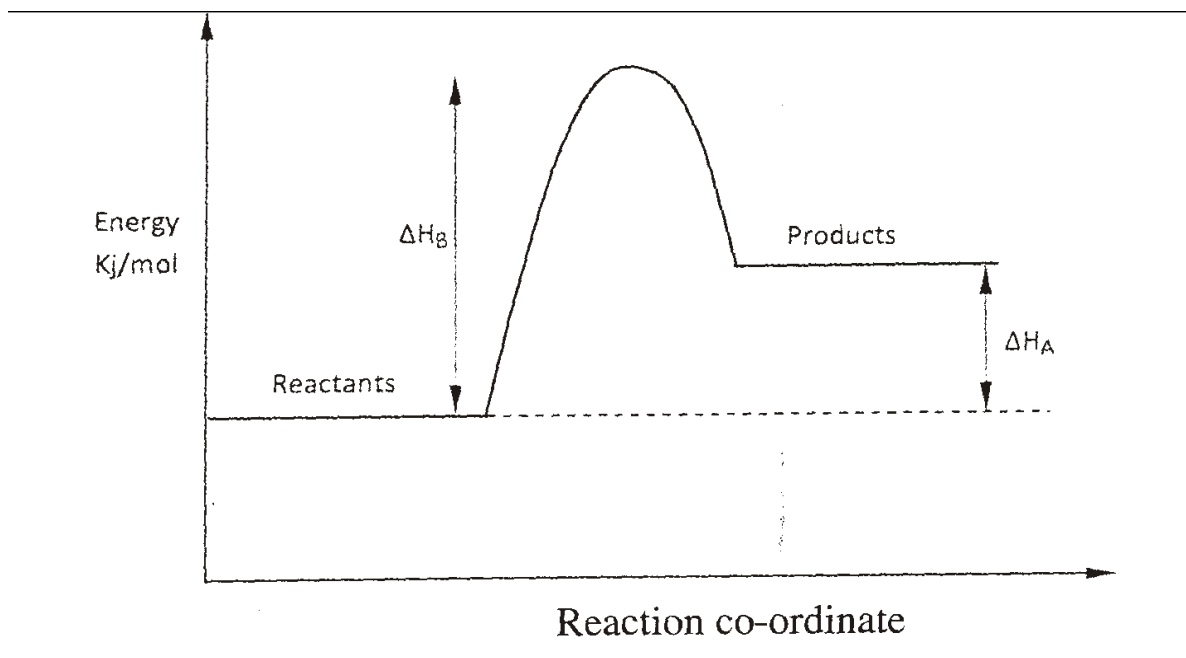

- (a) Give the name of ΔH_A (1 mk)
- (b) How can ΔH_B be reduced? Give a reason. (2 mks)
18. Acidified potassium manganate (VII) solution is decolourised when sulphur

(IV) oxide is bubbled through it. The equation for the reaction is given below.



(a) Which reactant is oxidised? Explain. (2 mks)

(b) Other than the manufacture of sulphuric (VI) acid, state one other use of sulphur (IV) oxide. (1 mk)

19. The set up shown below was used to investigate a property of hydrogen gas.

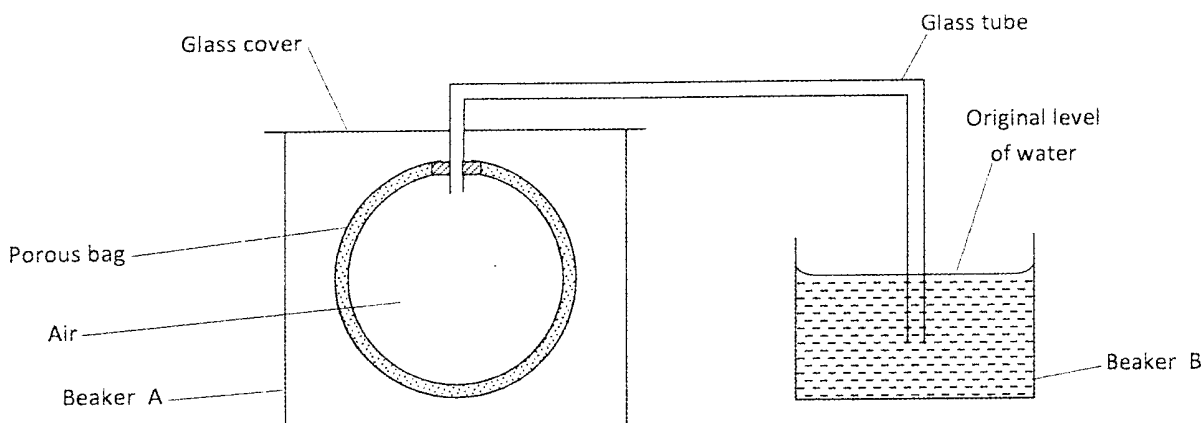

State and explain the observation that would be made in the glass tube if beaker A was filled with hydrogen gas. (3 mks)

20. Draw and name the isomers of pentane. (3 mks)

21. Give **two** uses of the polymer polystyrene. (1 mk)

22. Aluminium is both malleable and ductile,

(a) What is meant by?

(i) malleable; (1 mk)

(ii) ductile. (1 mk)

(b) State **one** use of aluminium based on:

(i) malleability (1mk)

(ii) ductility (1mk)

23. Describe how the percentage by mass of copper in copper carbonate can be determined. (3 mks)

24. The following set up of three test-tubes was used to investigate rusting of iron. Study it and answer the questions that follow.

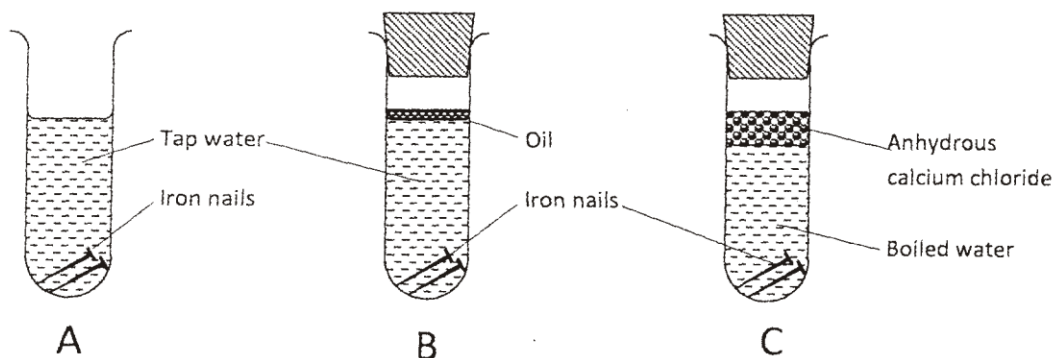

(a) Give a reason why rusting did not occur in test-tube C. (1 mk)

(b) Aluminium is used to protect iron sheets from rusting. Explain **two** ways in which aluminium protects iron from rusting. (2 mks)

25. Describe how a solid sample of potassium sulphate can be prepared starting with 200cm^3 of 2M potassium hydroxide. (3 mks)

26. Describe **two** chemical tests that can be used to distinguish ethanol from ethanoic acid. (3 mks)

27 (a) The electronic arrangement of the ion of element Q is 2.8.8. If the formula of the ion is Q^3 , state the group and period to which Q belongs.

Group: (1/2 mk)

Period:

($\frac{1}{2}$ mk)

(b) Helium, neon and argon belong to group 8 of the periodic table. Give:

(i) the general name of these elements;

(1 mk)

(ii) one use of these elements.

(1 mk)

28 The apparatus shown in the diagram below were used to investigate the products formed when concentrated sodium chloride was electrolysed using inert electrodes.

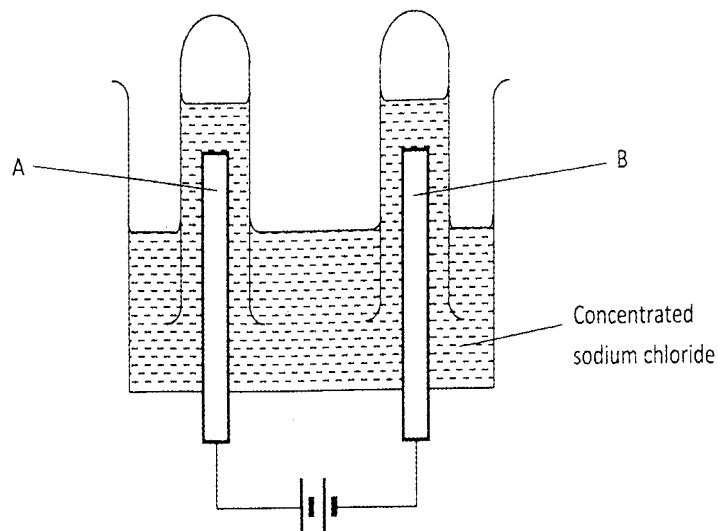

(a) Write the equation for the reaction that takes place at electrode A. (1 mk)

(b) If the concentrated sodium chloride was replaced with dilute sodium chloride, what product would be formed at electrode A? Explain. (2 mks)

29. a) State and explain what would happen if a dry blue litmus paper was dropped in a gas. (1mk)

- b) By using only dilute hydrochloric acid, describe how a student can distinguish between barium sulphite from barium sulphate. (2mks)

CHEMISTRY PAPER 1 KCSE 2013 THEORY

1. The set up below can be used to prepare oxygen gas. Study it and answer the questions that follow.

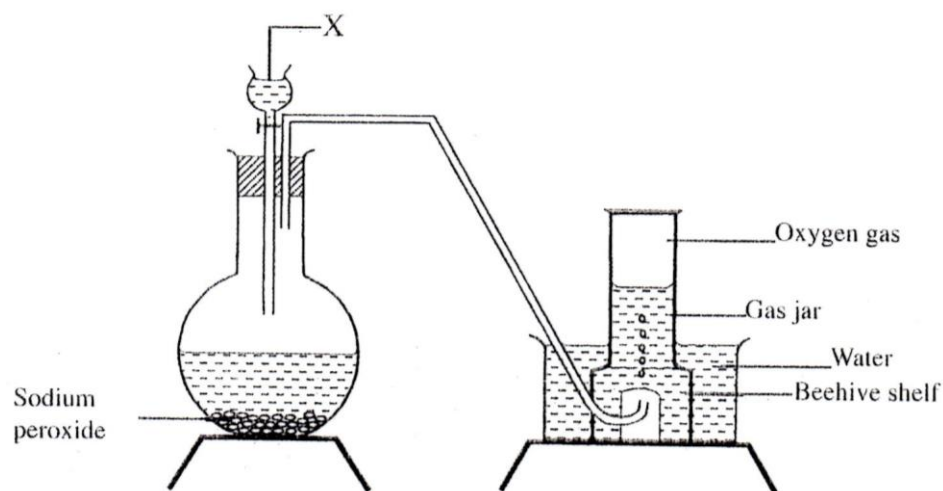

- (a) Identify X (1 mk)
- (b) What property of oxygen makes it possible for it to be collected as shown in the above set up? (1 mk)
- (c) State **two** uses of oxygen (1 mk)

2. Write equations to show the effect of heat on each of the following:
- (a) Sodium hydrogen carbonate (1 mk)
 - (b) Silver nitrate (1 mk)
 - (c) Anhydrous iron (II) sulphate (1 mk)
3. Describe an experiment procedure that can be used to extract oil from nut seeds (2 mks)
4. In terms of structure and bonding, explain the following observations:
- (a) The melting point of aluminum is higher than that of sodium (1½ mk)
 - (b) Melting point of chlorine is lower than that of sulphur (1½ mk)

5. The diagram below illustrates a method of preparing salts by direct synthesis

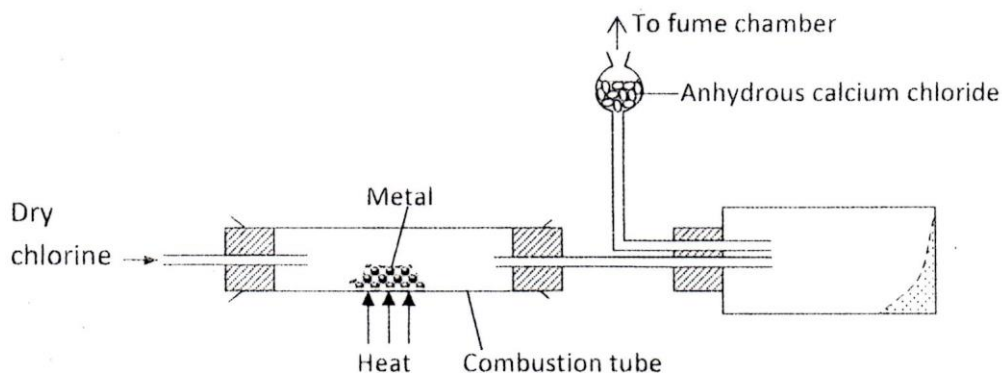

- (a) This method can be used to prepare either aluminum chloride or iron (III) chloride. Explain why it cannot be used to prepare sodium chloride. (2 mks)
 - (b) Describe how a sample of sodium chloride can be prepared in the laboratory by direct synthesis. (2 mks)
6. (a) A student electroplated a spoon with copper metal. Write an equation for the process that took place at the cathode. (1 mk)
- (b) Calculate the time in minutes required to deposit 1.184g of copper if a current

of 2 amperes was used. (1 Faraday = 96500 coulombs, Cu=63.5). (2 mks)

7. Study the flowchart below and answer the questions that follow:

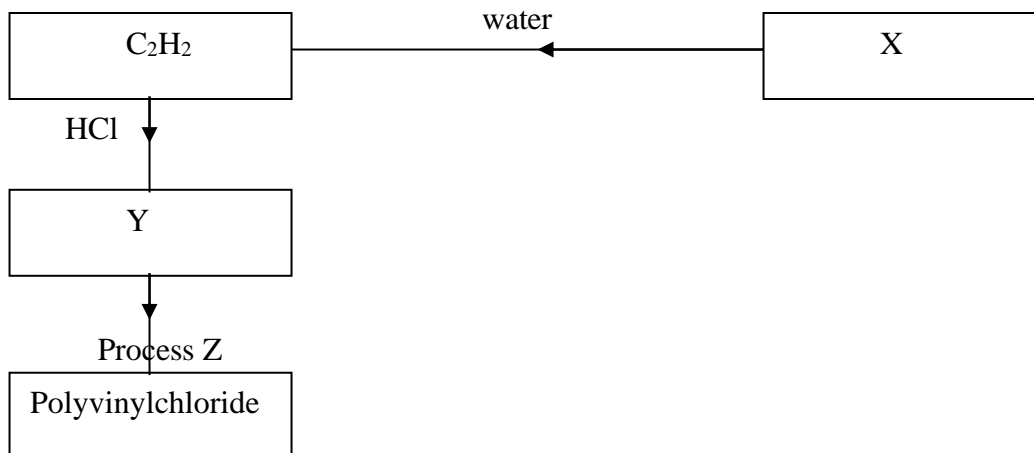

(a) Identify:

- (i) X (1 mk)
(ii) Y (1 mk)

(b) State two uses of polyvinylchloride (1 mk)

8. Draw a labeled diagram to illustrate how alpha, beta and gamma radiations can be distinguished from each other. (3 mks)

9. Aqueous hydrogen chloride reacts with potassium manganate (VII) to produce chlorine gas, while a solution of hydrogen chloride in methylbenzene has no effect on potassium manganate (VII). Explain this observation (2 mks)

10. The table below gives the solubility's of substances T and U at 10⁰c and 40⁰c.

Substance	Solubility g/100g water	
	10 ⁰ c	40 ⁰ c
T	40	65
U	15	17

When an aqueous mixture containing 55g of T and 12g of U at 80⁰c was cooled to 10⁰c, crystals formed.

a) Identify the crystals formed (1 mk)

- b) Determined the mass of the crystals formed (1 mk)
- c) Name the method used to obtain the crystals (1 mk)

11. Hydrazine gas,

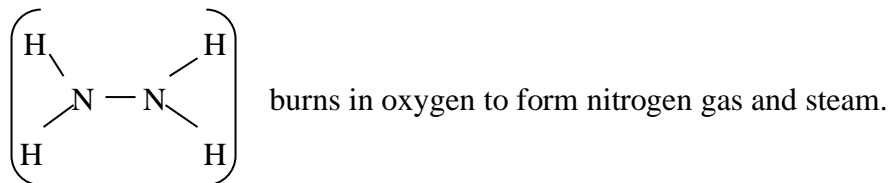

- a) Write an equation for the reaction (1 mk)
- b) Using the bond energies given below, calculate the enthalpy change for the reaction in (a) above (2 mks)

Bond	Bond energy (kj per mole)
$\text{N} \equiv \text{N}$	944
$\text{N} - \text{N}$	163
$\text{N} - \text{H}$	388
$\text{O} = \text{O}$	496
$\text{H} - \text{O}$	463

12. a) What would be observed if sulphur (IV) oxide is bubbled through acidified potassium manganate (VII) (1 mk)
- (b) In an experiment, sulphur (IV) oxide was dissolved in water to form solution L.
- (i) What would be observed if a few drops of barium nitrate solution were **immediately** added to solution L? (1 mk)
- (ii) Write an ionic equation for the reaction that occurred between solution L and aqueous barium nitrate in (b) (i) above. (1 mk)

13. The scheme below shows some reaction sequence starting with solid N. Study it and answer the questions that follows.

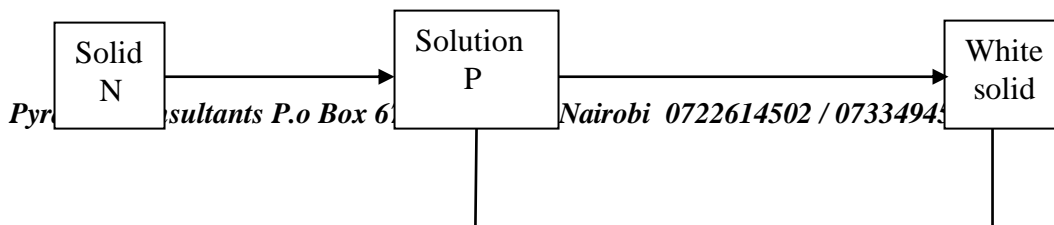

HCL(aq)
Step I

a few drops of NH₃(aq)
Step II

Mg(s)
Step IV

Excess NH₃(aq)
Step II

- a) Write the formula of the complex ion in solution Q. (1 mk)
- b) Write an equation for the reaction in step IV. (1 mk)
14. (a) State the Charles' law (1 mk)
- (b) A certain mass of gas occupies 146 dm³ at 291 K and 98.31 kPa.
What will be its temperature if its volume is reduced to 133 dm³ at 101.325 kPa? (2 mks)
15. The chromatogram below was obtained from a contaminated food sample P. Contaminants Q, R, S and T are suspected to be in P. Use it to answer the following questions.

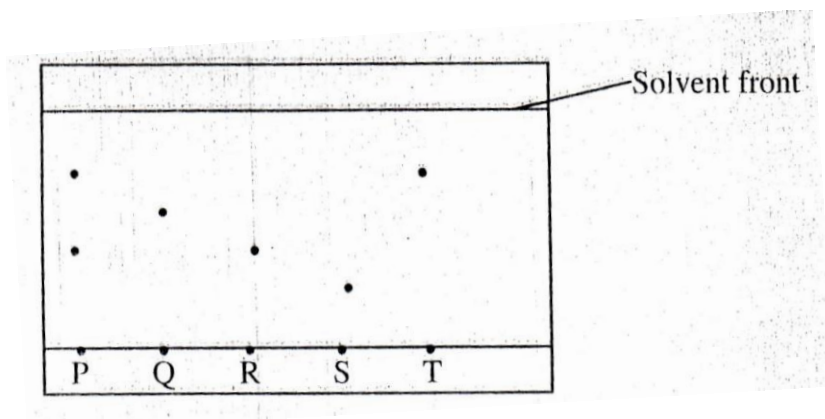

- a) Identify the contaminants in mixture P. (1 mk)
- b) Which is the most soluble contaminant in P.? (1 mk)
16. The curves below represent the change in mass when equal masses of powdered zinc and zinc granules were reacted with excess 2M hydrochloric acid. Study them and answer the question below.

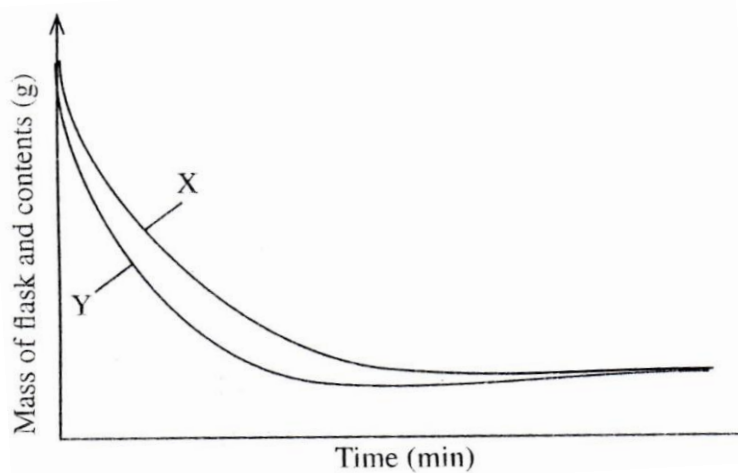

- Which curve represents the reaction with zinc granules? Explain your answer. (3 mks)
17. When fuels burn in the internal combustion engine at high temperature, one of the products formed is nitrogen (II) oxide.
- a) Write the equation for the formation of nitrogen (II) oxide. (1 mk)
- b) Give a reason why nitrogen (II) oxide is not formed at room temperature. (1 mk)

- c) Describe how formation of nitrogen (II) oxide in the internal combustion engine leads to gaseous pollution. (1 mk)

18. The set-up below was used to investigate the products of burning biogas (methane). Study it and answer the questions that follow.

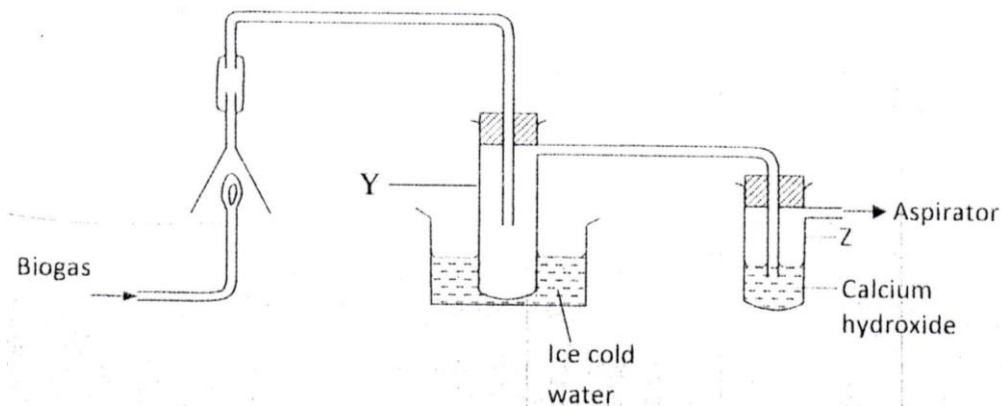

- a) What product will be formed in test-tube Y? (1 mk)
 b) State and explain the observations which would be made in Z? (2 mks)
19. (a) Diamond and graphite are allotropes of carbon. What is meant by an allotrope? (1 mk)
 (b) Explain why graphite can be used as a lubricant while diamond cannot. (1 mk)
20. The plots below were obtained when the atomic radii of some elements in groups I and II were plotted against atomic numbers.

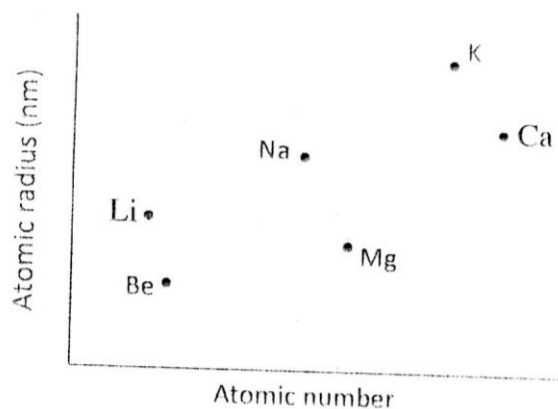

Explain:

- a) The trend shown by Li, Na and K. (1 mk)
 b) Why the atomic radii of elements Be, Mg, and Ca are lower than those of Li, Na and K. (2 mks)

21. On heating a pale green solid K, carbon (IV) oxide gas and a black solid M were formed. On reacting K with dilute hydrochloric acid, carbon (IV) oxide gas and green solution S were formed. When excess aqueous ammonia was added to solution S, a deep blue solution was formed.
- a) Identify the cation in solid K (1 mk)
 b) Identify the **two** anions in solution S. (2 mks)
22. a) Name **two** ores from which copper is extracted (1 mk)
 b) During extraction of copper metal, the ore is subjected to froth flotation. Give a reason why this process is necessary. (1 mk)
 c) Name **one** alloy of copper and state its use. (1 mk)
23. When 15 cm³ of a gaseous hydrocarbon, P, was burnt in 100cm³ of oxygen, the resulting gaseous mixture occupied 70cm³ at room temperature and pressure. When the gaseous mixture was passed through potassium hydroxide solution, its volume decreased to 25cm³
- a) What volume of oxygen was used during the reaction? (1 mk)
 b) Determine the molecular formula of the hydrocarbon (2 mks)
24. A solution was made by dissolving 8.2g of calcium nitrate to give 2 litres of solution. (Ca= 40.0; N=14.0; O= 16.0)
 Determine the concentration of nitrate ions in moles per litre. (3 mks)
25. State and explain what would happen if a dry red litmus paper was dropped in a gas jar of dry chlorine. (2 mks)
26. By using aqueous sodium chloride, describe how a student can distinguish calcium ions from lead ions. (2 mks)
27. A student investigated a property of acids M and N by reacting equal volumes of acid M and N of the same concentration with equal volumes of 2M potassium hydroxide. The results were recorded in the table below.

Acid	Rise in temperature(Δ)K
------	----------------------------------

M	4
N	2

- a) Which of the acids is likely to be a weak acid? Explain. (2 mks)
- b) Write the equation for the reaction between ethanoic acid and potassium hydroxide. (1 mk)
28. A student investigated the effect of an electric current by passing it through some substances.
The student used inert electrodes, and connected a bulb to the circuit. The table below shows the substances used and their states.

Experiment	Substance	State
1	Potassium Carbonate	Solid
2	Copper II Sulphate	Solution
3	Sugar	Solution
4	Lead II iodide	Molten

- a) In which experiments did the bulb **not** light? (1 mk)
- b) Explain your answer in (a) above. (2 mks)
29. A sample of hydrogen gas was found to be a mixture of two isotopes ${}^1_1\text{H}$ and ${}^2_1\text{H}$. Determine the relative molecular masses of the molecules formed, when each of these isotopes is burnt in oxygen. (O =16.0) (2 mks)

${}^1_1\text{H}$

${}^2_1\text{H}$

CHEMISTRY PAPER (233/1)

KCSE 2014 QUESTIONS

1. Explain how the hotness of a Bunsen burner flame can be increased (1 mk)

2. When dilute hydrochloric acid was reacted with solid B, a colourless gas which extinguished a burning splint was produced. When an aqueous solution of solid B was tested with a blue litmus paper, the paper turned red / pink.

(a) Identify the anion present in solid B. (1 mk)

(b) Write an ionic equation for the reaction between solid B and dilute hydrochloric acid. (1 mk)

3. Dry ammonia gas was passed over heated lead (II) oxide and the product passed over anhydrous Copper (II) sulphate as shown in the diagram below.

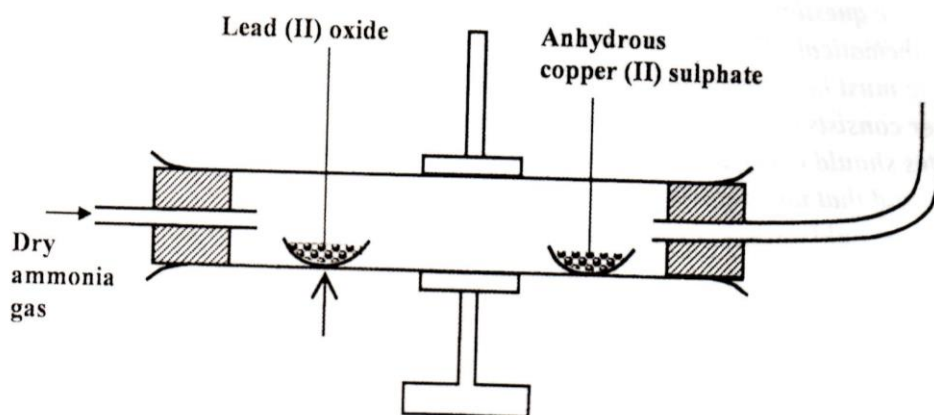

State:

(a) Two observations made in the combustion tube. (2 mks)

(b) The property of ammonia gas shown in this experiment (1 mk)

4. starting with zinc sulphate solution, describe how a sample of zinc oxide can be obtained (3 mks)

5. Explain how condition of electricity takes place in the following.
(a) Iron metal (1 mk)

(b) Molten lead (II) iodide (1 mk)

6. 100cm^3 of a sample of ethane gas diffuses through a porous pot in 100 seconds. What is the molecular mass of gas Q if 1000 cm^3 of the gas diffuses through the same porous not in 121 seconds under the same conditions? (C=12.0, H=1.0) (3 mks)

7. (a) Draw and name the isomers of butyne (2 mks)

(b) State **one** use of polystyrene. (1 mk)

8. Complete the nuclear reaction below

(a) $\frac{226}{88}\text{Q} \Rightarrow \frac{226}{88}\text{Q}$ (1 mk)

(b) State two uses of radioisotopes in health (2 mks)

9. The table below shows the relative molecular masses and boiling points of pentane and ethanoic acid

	Relative molecular mass	Boiling point ($^{\circ}\text{C}$)
Pentane	72	36
Ethanoic acid	60	118

Explain the large difference in boiling point between ethanoic acid and pentane. (2 mks)

10. One of the ores of copper has formula, CuFeS_2 .

(a) Describe how iron in the ore is removed during concentration of copper metal. (1 mk)

(b) State **two** environmental problems associated with extraction of copper metal. (2 mks)

11. Study the flow chart below and answer the questions that follow.

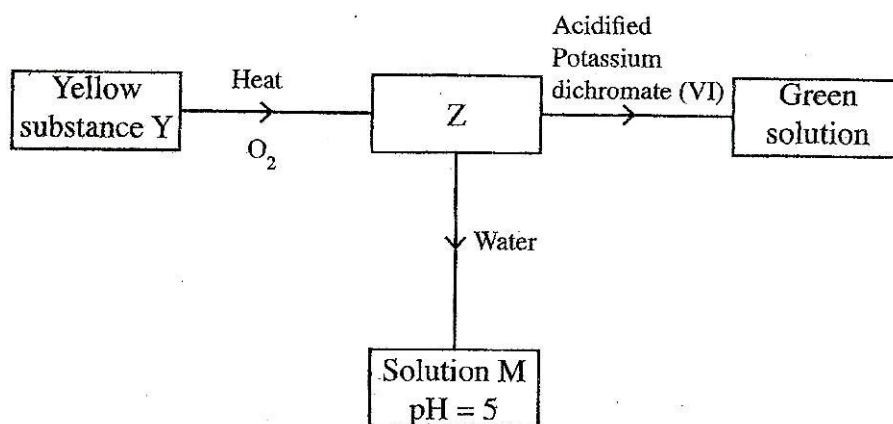

Identify Z and M. (2 mks)

Z.....

M.....

12. The table below shows the pH values of solutions A, B, C and D

Solution	A	B	C	D
pH	2	7	11	14

Select solutions in which a sample of lead (II) hydroxide is likely to dissolve. Give reasons for each solution selected. (3 mks)

13. 100cm^3 of 0.005 M sulphuric (VI) acid were placed in a flask and a small quantity of

anhydrous sodium carbonate added. The mixture was boiled to expel all the carbon (IV) oxide.

25cm³ of the resulting solution required 18cm³ of 0.1 M sodium hydroxide solution to neutralize it. Calculate the mass of sodium carbonate added.

(Na = 23.0; O=16.0; C=12.0)

(3 mks)

14. When 20cm³ of 1 M sodium hydroxide was mixed with 20cm³ of 1 M hydrochloric acid, the temperature rose by 6.7⁰c Assuming the density of the solution is 1 g/cm³ and the specific heat capacity of the solution is 4.2Jg⁻¹k⁻¹.

(a) Calculate the molar heat of neutralization;

(2 mks)

((b) When the experiment was repeated with 1 M ethanoic acid, the temperature changes was found to be lower than that with 1 M hydrochloric acid. Explain. (1 mk)

15. Study the set up below and answer the questions that follow

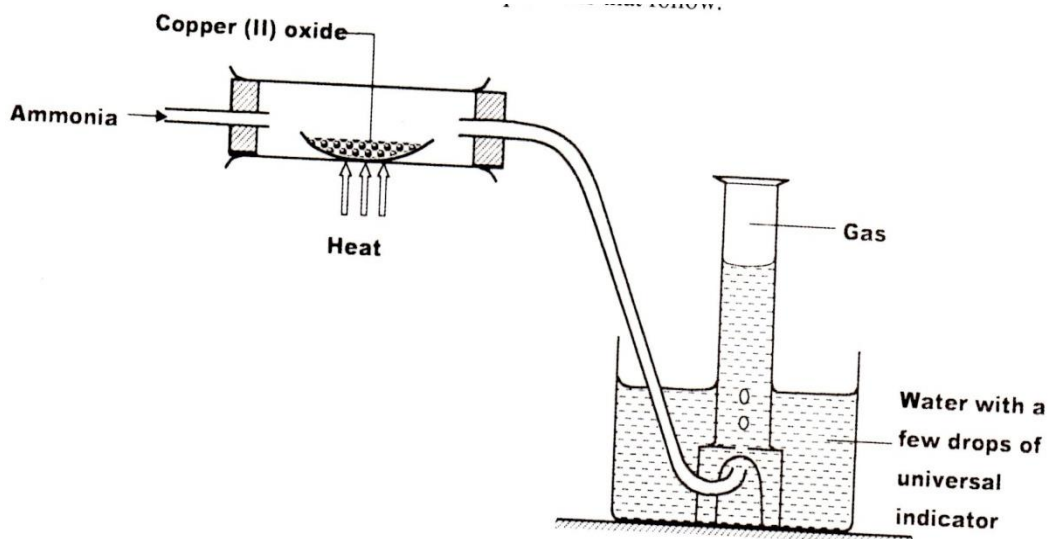

(a) Write an equation for the reaction between ammonia and copper (II) oxide.

(1 mk)

(b) During the experiment, the colour of the contents in the water trough changed. State the colour change observed and give an explanation.

(2 mks)

16. A measuring cylinder fitted with moist steel wool was inverted in a trough of water as shown in the diagram below

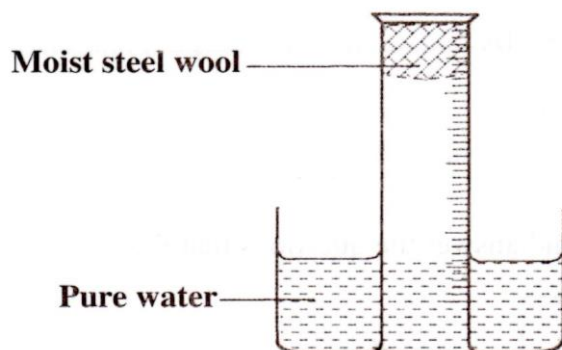

- (a) State and explain the observations made on the;
- i) Moist steel wool after four days. (1 mk)
 - ii) Water level in the measuring cylinder after four days. (1 mk)

(b) What would be the effect of using steel wool moistened with salty water? (1 mk)

17. In an experiment on rates of reaction, potassium carbonate was reacted with dilute sulphuric (VI) acid

- (a) What would be the effect of an increase in the concentration of the acid on the rate of the reaction? (1 mk)
- (b) Explain why the rate of reaction is found to increase with temperature. (2 mks)

18. Use the part of the periodic table given below to answer the questions that follow
(Letters are not the actual symbols of the elements)

				N		P	
Q	M						R

- a) Identify the element that forms giant covalent structures (1 mk)
- b) Identify **one** element that does not form compounds (1 mk)
- c) Write the formula for the nitride of M (1 mk)
19. Draw a set up that can be used to separate a mixture of sand and iodine (3 mks)
20. In the contact process, during the production of sulphur (VI) oxide, a catalyst is used. Give **two** reasons why vanadium (V) oxide is preferred to platinum. (2 mks)
21. Given that the atomic number of Y is 13 and that of Z is 9:
- a) Write the electronic arrangement of Y and Z; (1 mk)
- b) Draw the dot (.) and cross(x) diagram for the compound formed by Y and Z (1 mk)
22. The set up below was used to separate a mixture of methanol and propanol. Study it And answer the question that follow.

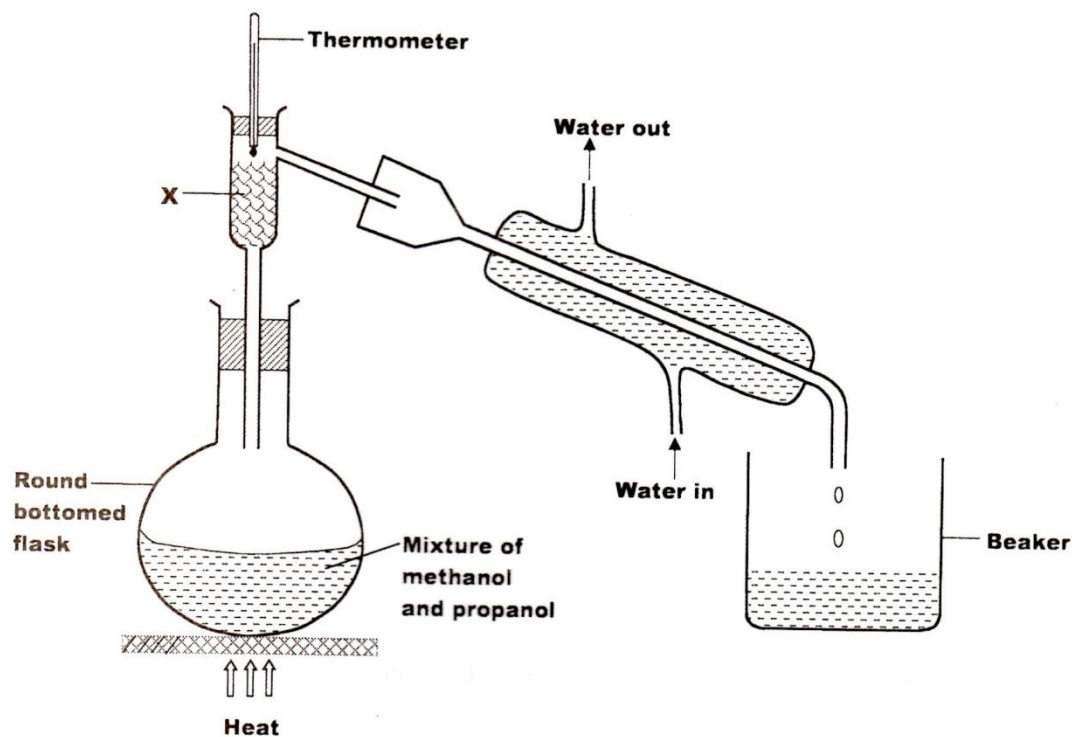

- a) State the function of X (1 mk)
- b) Which liquid will collect first in the beaker? give a reason. (2 mks)

23. Study the flow chart below and answer the question the follow.

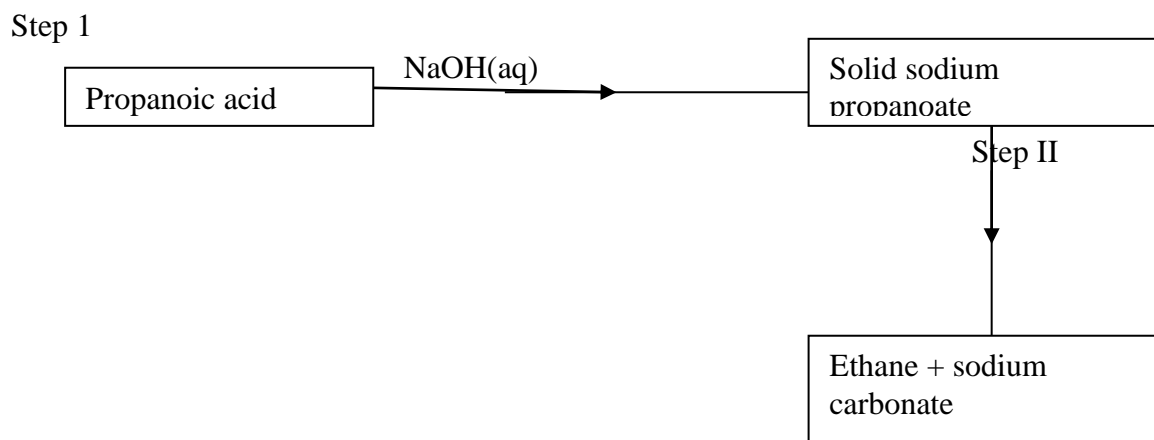

- a) Name the process in step I. (1 mk)
- b) Identify the reagent in step II. (1 mk)
- c) Give **one** use of ethane (1 mk)

24. (a) A student electrolyzed dilute sodium chloride solution using inert carbon electrodes. Name the products at:

i) Anode :

ii) Cathode: (2 mks)

(b) If the experiment was repeated using concentrated sodium chloride instead of dilute sodium chloride solution, write the half equation at the anode. (1 mk)

25. An organic compound had the following composition 37.21% carbon, 7.75% hydrogen and the rest chlorine. Determine the molecular formula of the compound, given that the molecular mass of the compound is 65. (C=12.0; H=1.0; CL=35.5) (3 mks)

26. Cotton is a natural polymer. State **one** advantage and **one** disadvantage of this polymer. (2 mks)

27. a) Name a suitable solvent for extracting an indicator from flowers: (1 mk)

b) Give a reason why the solvent named in (a) above is used (1 mk)

28. A student used the set up below to prepare a sample of nitrogen gas.

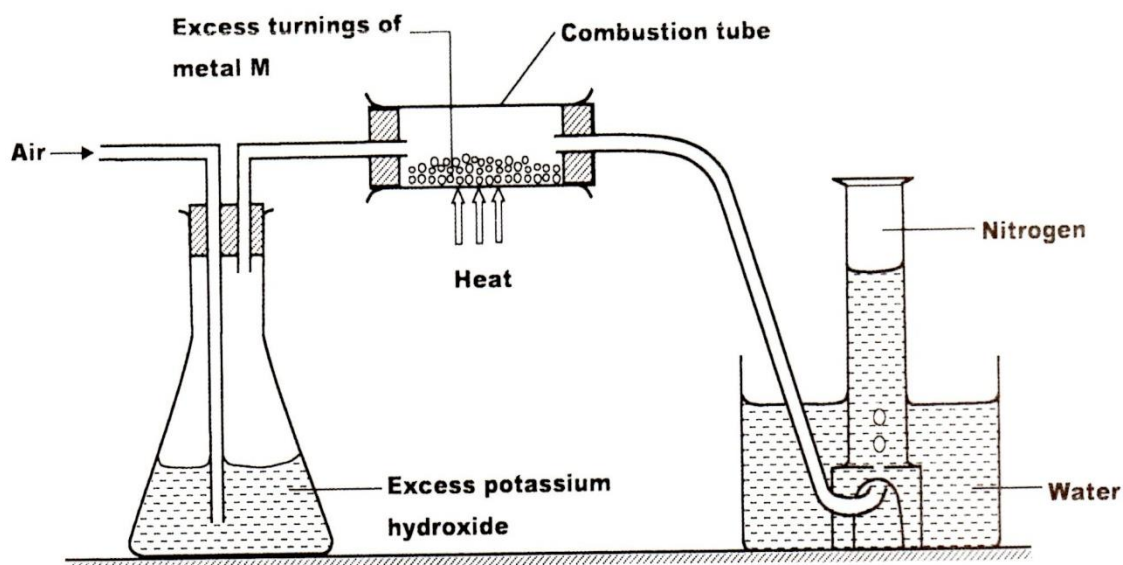

a) State the function of potassium hydroxide in the set up (1 mk)

b) Give a suitable metal M for use in the combustion tube (1 mk)

c) Give a reason why the nitrogen gas obtained is not pure. (1 mk)

29. a) What is meant by the term radical? (1 mk)

b) The table below contains atoms that form common radicals. Complete the table to show radicals formed from various atoms. (2 mks)

Element	N	S
H	NH_4^+	
O		

30. A gas jar full of chlorine water was inverted over water and allowed to stand for sometime

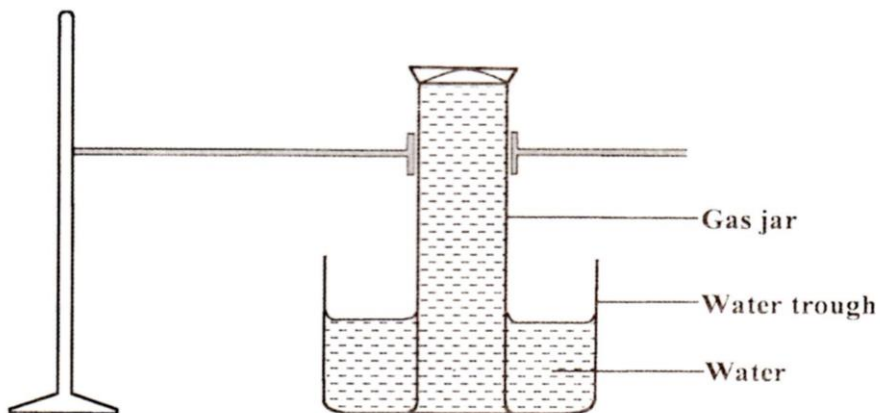

a) State and explain **two** observations made in the gas jar after some time. (2 mks)

b) Write the equation for the reaction between chlorine and hot concentrated potassium hydroxide (1 mk)

CHEMISTRY PAPER 233/1

KCSE 2015 QUESTIONS

1. (a) Give the name of the first member of the alkene homologous series. (1 mk)
- (b) Describe a chemical test that can be used to distinguish butanol from butanoic acid (2 mks)
2. (a) Name the raw material from which sodium is extracted. (1 mk)
- (b) Give a reason why sodium is extracted using electrolysis. (1 mk)
- (c) Give two uses of sodium metal. (1 mk)
3. (a) What is meant by lattice energy?
- (b) Study the energy level diagram below and answer the question that follows

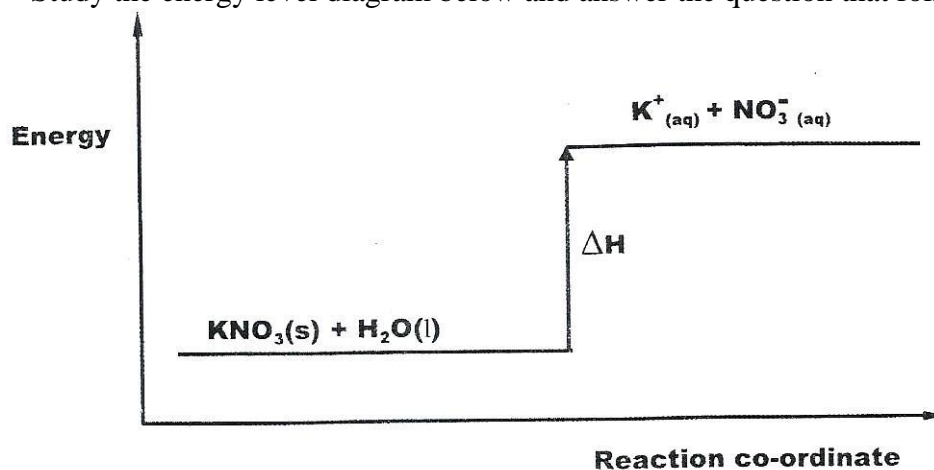

What type of reaction is represented by the diagram? (1 mk)

4. a) State the Boyles Law (1 mk)
- b) A gas occupies 500cm^3 at 27°C and $100,000\text{ Pa}$, What will be its volume at 0°C and 101325 Pa ? (2 mks)
5. Calculate the mass of Zinc oxide that will just neutralize dilute nitric (V) acid contain 12.6 g of nitric (V) acid in water. ($Z_n = 65.0$; $O = 16.0$, $H = 1.0$, $N = 14.0$).

6. Describe how sodium carbonate is used to remove water hardness (2 mks)

7. Hydrogen chloride gas can be prepared by reacting sodium chloride with an acid.

- (a) Write an equation for the reaction between sodium chloride and the acid. (1 mk)
- (b) Give two chemical properties of hydrogen chloride gas (1 mk)
- (c) State two uses of hydrogen chloride (1 mk)

8. When solid A was heated strongly, it gave off water and a solid residue. When water was added to the solid residue, the original solid A, was formed

- (a) What name is given to the process described? (1 mk)
- (b) Give one example of solid A (1 mk)

9. The set up below was used to investigate the reaction between dry hydrogen gas and copper (II) oxide

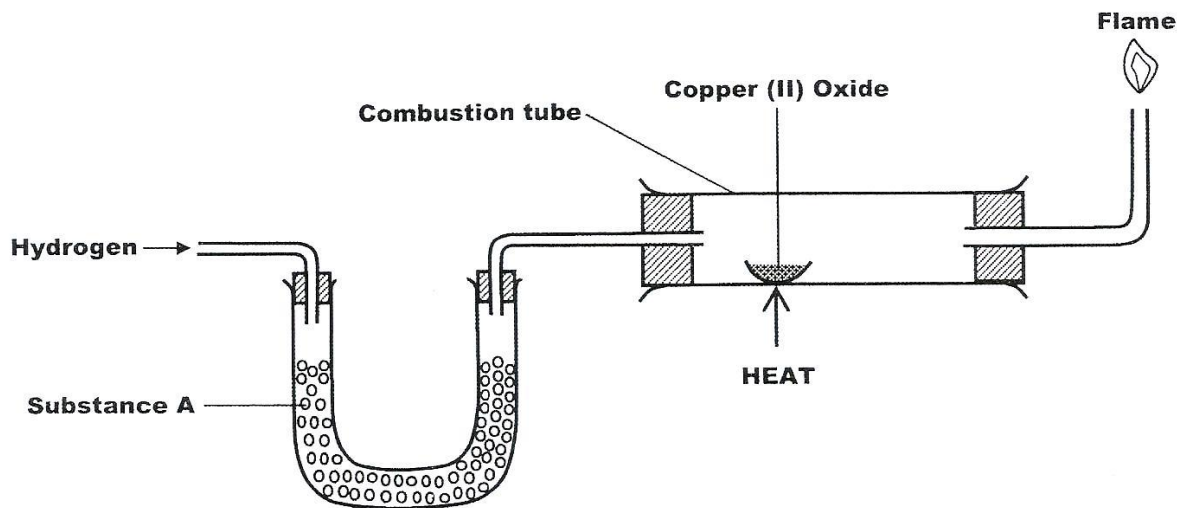

- a) Name substance A (1 mk)
- b) state the observation made in the combustion tube (1 mk)
- c) Explain the observation stated in (b) above. (1 mk)
10. The atomic number of an element, T is 15.
- (a) Write the electronic configuration of the ion T (1 mk)
- (b) Write the formula of an oxide of T. (1 mk)

11. Dilute sulphuric (VI) acid was electrolysed using platinum electrodes.
Name the product formed at the anode and give a reason for your answer. (2 mks)

12. The curve shown below shows the variation of time against temperature for the reaction between sodium thiosulphate and hydrochloric acid.

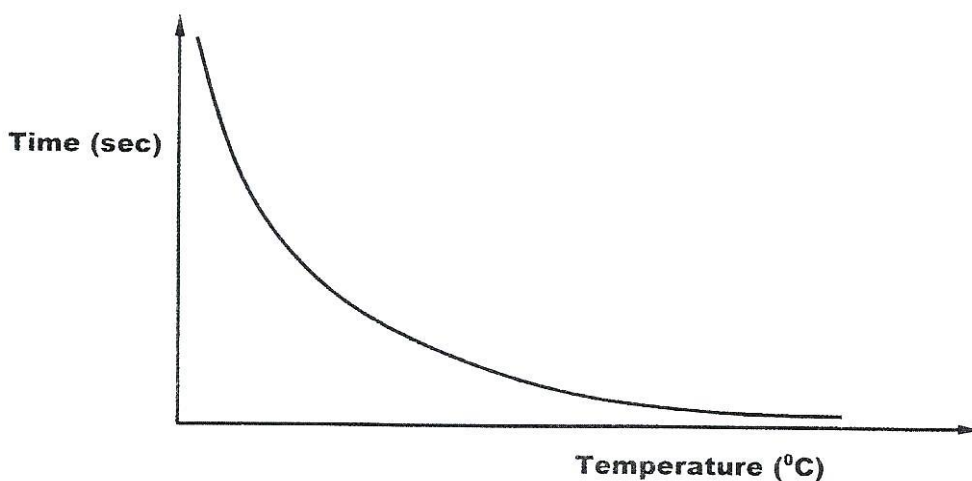

a) Write the equation for the reaction between sodium thiosulphate and dilute hydrochloric acid (1 mk)

b) Explain the shape of the curve (2 mks)

13. Dry ammonia and dry oxygen were reacted as shown in the diagram below

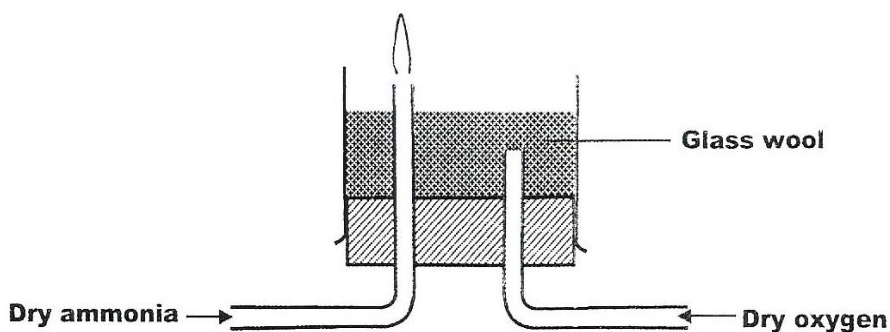

a) What is the purpose of the glass wool? (1 mk)

b) What products would be formed if red hot platinum was introduced into a mixture of ammonia and oxygen? (1 mk)

14. The table below shows behaviour of metals R, X, Y and Z. Study it and answer the questions that follow:

Metal	Appearance on exposure to air	Reaction in water	Reaction with dilute hydrochloric acid
R	slowly tarnishes	Slow	Vigorous
X	Slowly turns white	Vigorous	Violent
Y	No change	Does not react	Does not react
Z	No change	No reaction	Reacts moderately

- a) Arrange the metals in the order of reactivity starting with the most reactive (2 mks)
- b) Name a metal which is likely to be (1 mk)
- i X
- ii Y

15. Given the following substances: wood ash, lemon juice and sodium chloride.

- (a) Name one commercial indicator that can be used to show whether wood ash, lemon juice and sodium chloride are acidic, basic or neutral.
- b) Classify the substances in 15(a) above as acids, bases or neutral

Acid	Base	Neutral

16. The flow chart below shows various reactions of aluminium metal. Study it and answer the questions that follow

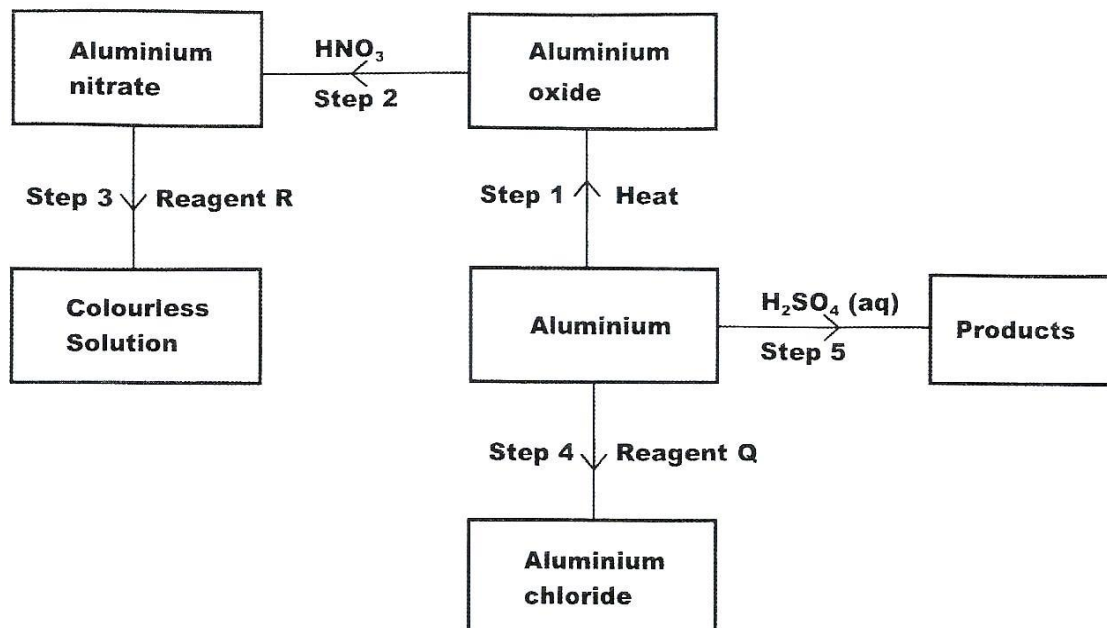

- A i) Other than water, name another reagent that could be R (1 mk)
 ii) Write the formula of reagent Q (1 mk)
- b) Write an equation or the reaction in step 5. (1 mk)

17. (a) One of the allotropes of sulphur is rhombic sulphur, name the other allotrope. (1 mk)
- (b) Concentrated sulphuric (VI) acid reacts with ethanol and copper. State the property of the acid shown in each case. (2 mks)
- (i) Ethanol
- (ii) Copper

18. Study the standard electrode potentials in the table below and answer the questions that follow.

	E^θ volts
$\text{Cu}^{2+}_{(\text{aq})} + 2\text{e} \rightarrow \text{Cu}_{(\text{s})};$	+ 0.34
$\text{Mg}^{2+}_{(\text{aq})} + 2\text{e} \rightarrow \text{Mg}_{(\text{s})};$	- 2.38
$\text{Ag}^{2+}_{(\text{aq})} + \text{e} \rightarrow \text{Ag}_{(\text{s})};$	+ 0.80
$\text{Ca}^{2+}_{(\text{aq})} + 2\text{e} \rightarrow \text{Ca}_{(\text{s})};$	- 2.87

- (a) Which of the metals is the strongest reducing agent? (1 mk)
- (b) What observations will be made if a silver coin was dropped into an aqueous solution of copper (II) sulphate? Explain. (2 mks)
19. A radioactive substance weighing M kg took 1900 years for the original mass to reduce to 15 kg. Given that the half life of the radioactive substance is 380 years; (2 mks)
- (a) Determine the original mass of the radioactive substance.
- (b) State two uses of radioactivity in medicine. (1 mk)
20. A crystal of iodine, heated gently in a test tube gave off a purple vapour.
- (a) Write the formula of the substance responsible for the purple vapour. (1 mk)
- (b) What type of bond is broken when the iodine crystal is heated gently? (1 mk)
- (c) State one use of iodine. (1 mk)
21. Describe how samples of lead (II) sulphate, ammonium chloride and sodium chloride can be obtained from a mixture of the three. (3 mks)

22. Study the flow chart below and use it to answer the questions that follows

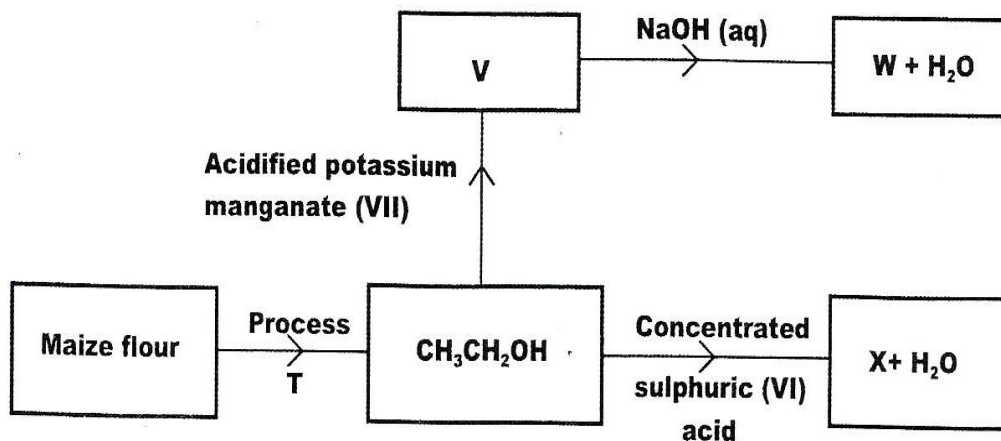

- a) Name process T (1 mk)
- b) Give the formula of W. (1 mk)
- c) State two uses of X (1 mk)

23. The table below is part of the periodic table. The letters are not the actual symbols of the elements. Study it and answer the questions that follows.

a) Select an element which is stored in paraffin in the laboratory

					C	D	E	F	
G	H						I		

(b) How do the ionic radii of E and I compare? Explain (2 mks)

24. The graph below is a cooling curve for water. Study it and answer the questions that follow

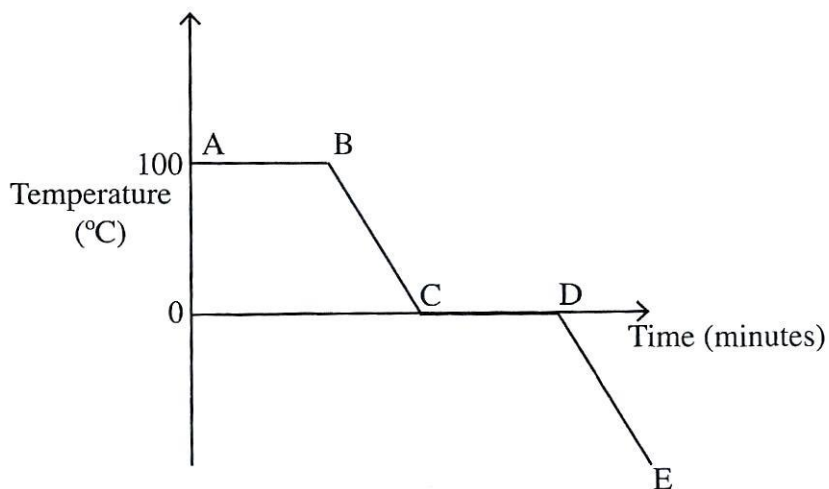

- (a) Explain what happens to the molecules of water in the region BC in terms of kinetic theory. (2 mks)
- (b) In what state is the water in the region DE?
25. Starting with barium nitrate solution, describe how a pure sample of barium carbonate can be prepared in the laboratory. (3 mks)
26. A hydrocarbon contains 14.5% of hydrogen. If the molar mass of the hydrocarbon is 56, determine the molecular formula of the hydrocarbon. (C = 12.0; H = 1.0) (3 mks)
27. (a) Describe how carbon (IV) oxide can be distinguished from Carbon II Oxide using calcium hydroxide solution. (2 mks)
- (b) What is the role of carbon (IV) oxide in fire extinguishing? (1 mk)
28. (a) State one source of alkanes. (1 mk)
- (b) Ethane gas was reacted with 1 mole of bromine gas. State one observation made during this reaction. (1 mk)

29. An electric current was passed through several substances and the results obtained recorded in the table below.

Substance	Physical state at room temperature	Conductivity	Products	
			Anode	Cathode
A	Liquid	Does not conduct	-	-
B	Solid	Conducts	-	-
C	Liquid	Conducts	Green gas	Grey solid
D	Liquid	Conducts	Brown gas	Grey solid
E	Liquid	Conducts	-	-

Which of these substance is likely to be

- a) Magnesium (1 mk)
- b) Hexane (1 mk)
- c) lead (II) bromide ? (1 mk)

CHEMISTRY PAPER 233/1
K.C.S.E 2016 QUESTIONS

1. A student investigated the effect of an electric current by passing it through some substances. The student used inert electrode and connected a bulb to the circuit. The table below shows the substances used and their states.

experiment	substances	states
1	potassium carbonate	Solid
2	copper (II) Sulphate	Solution
3	sugar	Solution
4	Lead (II) Iodide	Molten

- a) In which experiment did the bulb not light? (1mk)
- b) Explain your answer in (a) above (2 mks)
2. An alkanol has the following composition by mass ; hydrogen 13.5% , oxygen 21.6% and carbonate 64.9%
- a) Determine the empirical formula of the alkanol. (C=12.0, H=1.0, O=16) (2 mks)
- b) Given that the empirical formula and the molecular formula of the alkanol are the same, draw the structure of the alkanol (1 mk)

3. The figure below shows an energy cycle

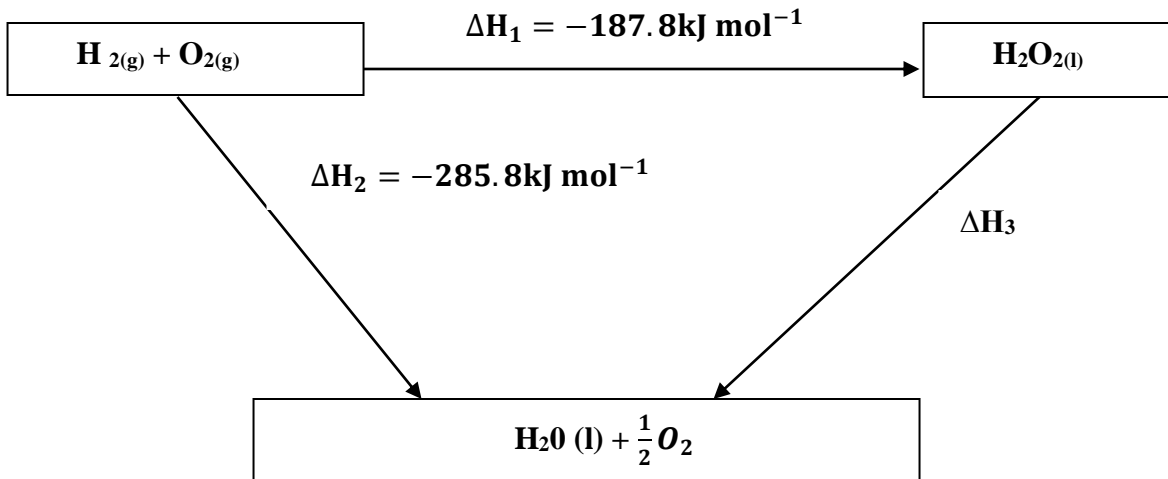

- Give the name of the enthalpy change ΔH_1 . (1 mk)
- Determine the value of ΔH_3 . (2 Mks)

4. The set up below was used to investigate the reaction between dry hydrogen gas and copper (II) oxide

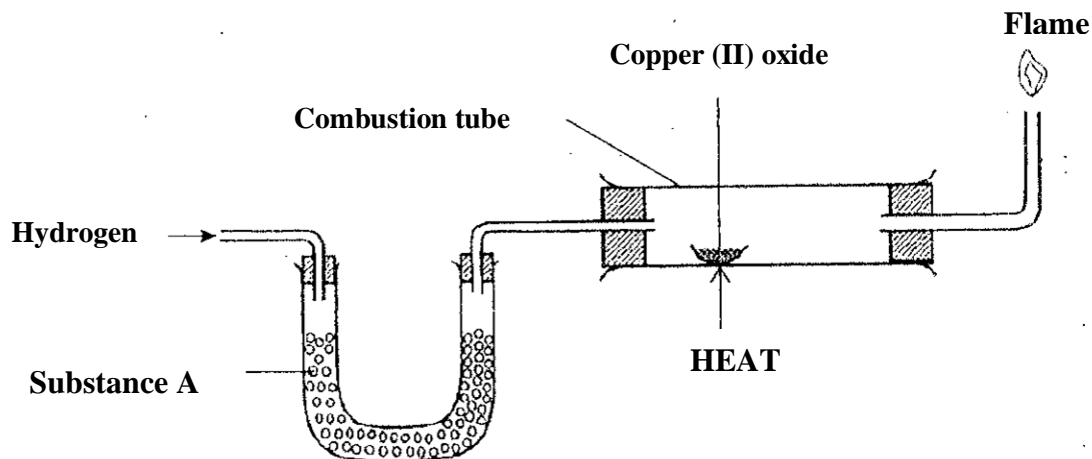

- Name substance A (1 mk)
 - State the observation made in the combustion tube (1 mk)
 - Explain the observation made in (b) above (1 mk)
5. Starting with sodium metal, describe how a sample of crystals of sodium hydrogen carbonate may be prepared (3 mks)

6. Ammonium ion has the following structure

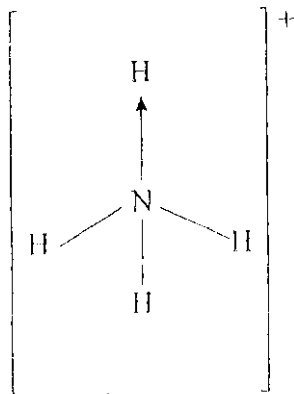

Label on the structure the

- a) Covalent bond (1 mk)
- b) Coordinate(dative) bond (1 mk)

7. When 8.53g of sodium nitrate was heated in an open test tube, the mass of oxygen gas produced was 0.83g. Given the equation of the reaction as



Calculate the percentage of sodium nitrate that was converted to sodium nitrite
(Na = 23.0, N =14.0, O=16.0)

8. Aluminium is both malleable and ductile

- a) What is meant by?
 - i)Malleable (1/2 mks)
 - ii)Ductile (1/2 mks)

- b) State one use of aluminium based on
 - i)Malleable (1/2 mks)
 - ii)Ductile (1/2 mks)

9. The diagram below represents the set up that was used to prepare and collect hydrogen chloride gas in the laboratory

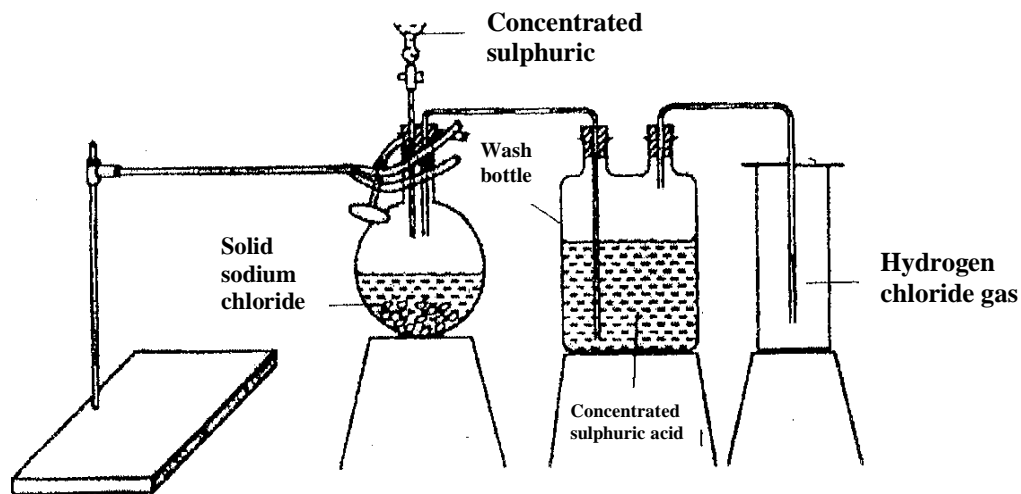

a) State the purpose of concentrated sulphuric acid in the wash bottle (1 mk)

b) Write an equation for the reaction between dry hydrogen chloride gas and heated iron (1 mk)

10. Iron (III) oxide was found to be contaminated with copper (II) sulphate. Describe how pure sample of iron (III) oxide can be obtained.

11. Complete the nuclear equation below

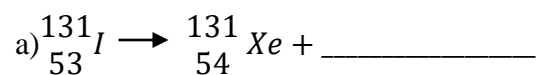

b) The half life of ${}_{53}^{131}\text{I}$ is 8 days. Determine the mass of ${}_{53}^{131}\text{I}$ remaining if 50 grams decayed for 40 days.

c) Give one harmful effect of radioisotopes.

12. During an experiment, chlorine gas was bubbled into a solution of potassium iodide

- a) State the observations made (1 mk)
b) Using an ionic equation, explain why the reaction is redox (2 mks)

13. a) Draw the structure of compound N formed in the following reaction (1 mk)

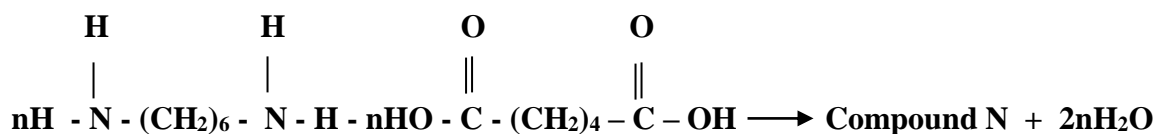

- b) Give one use of compound N (1 mk)

14. When fuel burns in the internal combustion engine at high temperature, one of the products formed is nitrogen (II) oxide

- a) Write the equation for the formation of nitrogen (II) oxide (1 mk)
b) Give a reason why nitrogen (II) oxide is not formed at room temperature (1 mk)
c) Describe how formation of nitrogen (II) oxide in the internal combustion engine lead to gaseous pollution (2 mks)

15. Sodium hydroxide can be prepared by the following methods; I and II

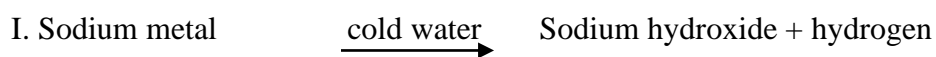

- a) Name one precaution that needs to be taken in method I (1 mk)
b) Give the name of process A (1 mk)
c) Give one use of sodium hydroxide (1 mk)

16. The atomic number of sulphur is 16. Write the electron arrangement of sulphur in the following ? (2 mks)

a) H₂S

b) SO₃²⁻

17. A compound whose general formula is M(OH) ₃ reacts as shown by the equation.

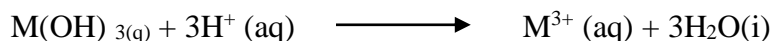
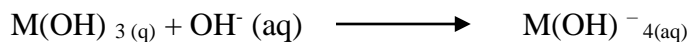

(a) What name is given to compounds which behave like M(OH) in the two reactions. (1 mk)

(b) Name **two** elements whose hydroxides behave like that of M. (2 mks)

18. A water trough, aqueous sodium hydroxide, burning candle, watch glass and a graduated jar were used in an experimental set up to determine the percentage of active part of air. Draw a labelled diagram of the set up at the end of the experiment. (3 mks)

19. In an experiment on rates of reaction, potassium carbonate was reacted with dilute sulphuric (VI) acid.

(a) What would be the effect of an increase in the concentration of the acid on the rate of the reaction? (1 mk)

(b) Explain why the rate of reaction is found to increase with temperature (1mk)

20. 60cm³ of oxygen gas diffused through a porous partition in 50 seconds. How long would it take 60cm³ sulphur (IV) oxide gas to diffuse through the same partition under the same condition (S=32.0, O=16.0)

21. Draw and name the isomers of pentane (3mks)

22. The set up below was used to collect a dry sample of a gas

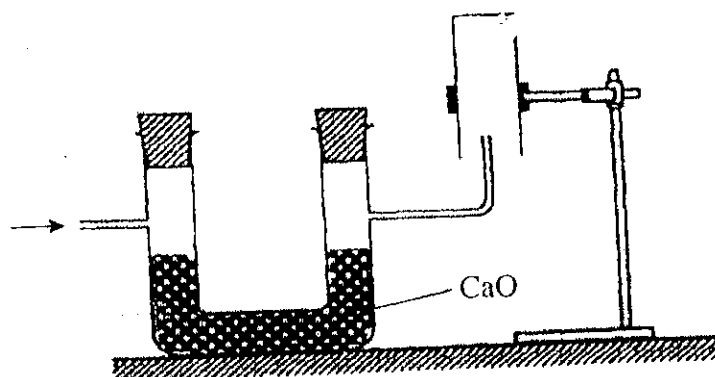

Give two reasons why the set up cannot be used to collect carbon (IV) oxide gas (2 mks)

23. Given the following substances; wood ash, lemon juice and sodium chloride.

a) Name one commercial indicator that can be used to show whether wood ash, lemon juice and sodium chloride are acidic, basic or neutral (1 mk)

b) Classify the substances in (a) above as acids bases or neutral (2mks)

acid	base	neutral

24. Describe how a solid sample of potassium sulphate can be prepared starting with 200cm³ of potassium hydroxide (3 mks)

25. Charcoal is a fuel that is commonly used for cooking. when it burns it forms two oxides

a) Name the two oxides (2 mks)

b) State one use of the two oxides (1 mk)

26. Hydrogen sulphide is a highly toxic and flammable gas. It is normally prepared in a fume chamber

a) Name two reagents that can be used to prepare hydrogen sulphide in the laborator (1 mk)

b) One of the use of hydrogen sulphide is to produce sulphur as shown in the following equation.



Identify the reducing agent in this reaction and give a reason for your answer (1mk)

c) Other than production of sulphuric (VI) acid , State one commercial use of sulphur (1 mk)

27. Describe an experimental procedure that can be used to extract oil from nut seeds. (2 mks)

28. A mixture contains ammonium chloride, copper (II) oxide and sodium chloride.
Describe how each of the substances can be obtained from the mixture (3 mks)

29. When a student was stung by a nettle plant, a teacher applied an aqueous solution of ammonia to the affected area of the skin and the student was relieved of pain. Explain. (2 mks)